



# Swing-Arm Tire Changer

## Installation and Operation Manual

Manual P/N 5900171 — Manual Revision C — December 2019

Model:

- R745



**Designed and engineered in Southern California, USA. Made in China.**

 **DANGER**

**Read the *entire contents* of this manual *before* using this product.** Failure to follow the instructions and safety precautions in this manual can result in serious injury or death. Make sure all other operators also read this manual. Keep the manual near the product for future reference. By proceeding with installation and operation, you agree that you fully understand the contents of this manual.

**Manual.** R745 Swing-Arm Tire Changer, *Installation and Operation Manual*, Manual P/N 5900171, Manual Revision C, released December 2019.

**Copyright.** Copyright © 2019 by BendPak Inc. All rights reserved. You may make copies of this document if you agree that: you will give full attribution to BendPak Inc., you will not make changes to the content, you do not gain any rights to this content, and you will not use the copies for commercial purposes.

**Trademarks.** BendPak, the BendPak logo, Ranger, and the Ranger logo are registered trademarks of BendPak Inc. All other company, product, and service names are used for identification only. All trademarks and registered trademarks mentioned in this manual are the property of their respective owners.

**Limitations.** Every effort has been made to have complete and accurate instructions in this manual. However, product updates, revisions, and/or changes may have occurred since this manual was published. BendPak Ranger reserves the right to change any information in this manual without incurring any obligation for equipment previously or subsequently sold. BendPak Ranger is not responsible for typographical errors in this manual. You can always find the latest version of the **manual for your product on the Ranger website**.

**Warranty.** The BendPak Ranger warranty is more than a commitment to you: it is also a commitment to the value of your new product. For full warranty details, contact your nearest BendPak Ranger dealer or visit [bendpak.com/support/warranty](http://bendpak.com/support/warranty). Go to [bendpak.com/support/register-your-product/](http://bendpak.com/support/register-your-product/) and fill out the online form to register your product (be sure to click **Submit**).

**Safety.** Your new product was designed and manufactured with safety in mind. Your safety also depends on proper training and thoughtful operation. Do not set up, operate, maintain, or repair the unit without reading and understanding this manual and the labels on it; **do not use this product unless you can do so safely!**

**Owner Responsibility.** In order to maintain your product properly and to ensure operator safety, it is the responsibility of the product owner **to read and follow these instructions**:

- Follow all installation, operation, and maintenance instructions.
- Make sure product installation and operation conforms to all applicable local, state, and federal codes, rules, and regulations, such as state and federal OSHA regulations and electrical codes.
- Read and follow all safety instructions. Keep them readily available for operators.
- Make sure all operators are properly trained, know how to safely operate the unit, and are properly supervised.
- Do not operate the product until you are certain all parts are in place and operating correctly.
- Carefully inspect the product on a regular basis and perform all maintenance as required.
- Service and maintain the unit only with approved replacement parts.
- Keep the manual with the product and make sure all labels are clean and visible.
- **Only use this product if it can be used safely!**

**Unit Information.** Enter the Model Number, Serial Number, and the Date of Manufacture from the label on your unit. This information is required for part or warranty issues.

Model: \_\_\_\_\_

Serial: \_\_\_\_\_

Date of Manufacture: \_\_\_\_\_

MODEL NO.	R745
SERIAL NO.	12345-678-910
REVISION	
DATE OF MFG.	09/19
VOLTAGE	110V/220V, 50Hz/60Hz, 1 Ph.



 **DANGER!**  
Disconnect Power  
Before Servicing.

**Ranger Products™**  
1645 Lemonwood Drive • Santa Paula, CA 93060  
[www.rangerproducts.com](http://www.rangerproducts.com)  
ENGINEERED BY RANGER PRODUCTS USA • MADE IN CHINA

---

# Table of Contents

<b>Introduction</b> .....	<b>3</b>	<b>Installation</b> .....	<b>11</b>
<b>Shipping Information</b> .....	<b>4</b>	<b>Operation</b> .....	<b>22</b>
<b>Safety Considerations</b> .....	<b>4</b>	<b>Maintenance</b> .....	<b>48</b>
<b>Components</b> .....	<b>6</b>	<b>Troubleshooting</b> .....	<b>51</b>
<b>FAQs</b> .....	<b>8</b>	<b>Labels</b> .....	<b>52</b>
<b>Specifications</b> .....	<b>9</b>	<b>Parts</b> .....	<b>55</b>
<b>Installation Checklist</b> .....	<b>10</b>	<b>Maintenance Log</b> .....	<b>67</b>

## Introduction

This manual describes the following Tire Changer:

- **R745.** Swing Arm, 110 or 220 VAC power, for demounting, mounting, and inflating automobile and light truck single-piece Tires.

More information about BendPak Ranger products is available at [rangerproducts.com](http://rangerproducts.com).

***This manual is mandatory reading for all users*** of the R745, including anyone who sets up, operates, maintains, or repairs it.

You can always find the latest version of the [manual for your product on the BendPak Ranger website](#).

** DANGER** Be very careful when setting up, operating, maintaining, or repairing this equipment; failure to do so could result in property damage, product damage, injury, or (in very rare cases) death. Make sure only authorized personnel operate this equipment. All repairs must be performed by an authorized technician. Do not make modifications to the unit; this voids the warranty and increases the chances of injury or property damage. Make sure to read and follow the instructions on the labels on the unit.

Keep this manual on or near the equipment so that anyone who uses or services it can read it.

Technical support and service for your Tire Changer is available from your distributor or by calling **BendPak Ranger at (805) 933-9970**. You may also call regarding parts replacement (please have the serial number and model number of your unit available).

---

# Shipping Information

Your equipment was carefully checked before shipping. Nevertheless, you should thoroughly inspect the shipment **before** you sign to acknowledge that you received it.

When you sign the bill of lading, it tells the carrier that the items on the invoice were received in good condition. **Do not sign the bill of lading until after you have inspected the shipment.** If any of the items listed on the bill of lading are missing or damaged, do not accept the shipment until the carrier makes a notation on the bill of lading that lists the missing or damaged goods.

If you discover missing or damaged goods **after** you receive the shipment and have signed the bill of lading, notify the carrier at once and request the carrier to make an inspection. If the carrier will not make an inspection, prepare a signed statement to the effect that you have notified the carrier (on a specific date) and that the carrier has failed to comply with your request.

It is difficult to collect for loss or damage after you have given the carrier a signed bill of lading. If this happens to you, file a claim with the carrier promptly. Support your claim with copies of the bill of lading, freight bill, invoice, and photographs, if available. Our willingness to assist in helping you process your claim does not make us responsible for collection of claims or replacement of lost or damaged materials.

## Safety Considerations

**Read this manual carefully before using your new product.** Do not set up or operate the product until you are familiar with all operating instructions and warnings. Do not allow anyone else to operate the product until they are also familiar with all operating instructions and warnings.

 **WARNING** There are many moving parts on a Tire Changer; keep clear of these moving parts and the Tire being changed. In particular, when inflating a Tire, never lean over the Tire; if it were to explode (which does happen), the force could injure or kill the Operator or bystanders. During inflation, the Operator should be as far away from the Tire as possible and all bystanders must be at least 30 feet away.

### Safety Information

Please note the following:

- The product is a Tire Changer. **Use it only for its intended purpose.**
- The product **must** only be operated by authorized, trained, properly supervised personnel. Keep children and untrained personnel at least 30 feet away from the product when it is in use.
- Always follow all applicable local, state, and federal codes, rules, and regulations, including (but not limited to) OSHA standard 1910.177 (Servicing multi-piece and single piece rim wheels).
- You **must** wear OSHA-approved (publication 3151) Personal Protective Equipment at all times when installing, using, maintaining, or repairing the Tire Changer. Leather gloves, steel-toed work boots, eye protection, back belts, and hearing protection **are mandatory.**
- Do not use the product while tired or under the influence of drugs, alcohol, or medication.
- Do not use the product in the presence of cigarette smoke, dust, or flammable liquids or gases. Use the product indoors in a well-ventilated area.
- Do not make any modifications to the product; this voids the warranty and increases the chances of injury or property damage. **Do not modify any safety-related features in any way.**

- 
- Make sure all Operators read and understand this *Installation and Operation Manual*. Keep the Manual near the Tire Changer at all times.
  - Make a visual inspection of the Tire Changer every day. Do not use the product if you find any missing or damaged parts. Instead, take the Tire Changer out of service, then contact an authorized repair facility, your distributor, or **BendPak Ranger at (805) 933-9970**.
  - BendPak Ranger recommends making a **thorough** inspection of the product once a month. Replace any damaged or severely worn parts, decals, or warning labels.

## Symbols

Following are the symbols that may be used in this Manual:



**DANGER**

Calls attention to a hazard that **will** result in death or injury.



**WARNING**

Calls attention to a hazard or unsafe practice that **could** result in death or injury.



**CAUTION**

Calls attention to a hazard or unsafe practice that could result in personal injury, product damage, or property damage.

**NOTICE**

Calls attention to a situation that, if not avoided, could result in product or property damage.



**Tip**

Calls attention to information that can help you use your product better.

## Liability Information

BendPak Ranger assumes **no** liability for damages resulting from:

- Use of the equipment for purposes other than those described in this Manual.
- Modifications to the equipment without prior, written permission from BendPak Ranger.
- Damage to the equipment from external influences.
- Incorrect operation of the equipment.

# Components

The following graphic identifies the main components of the Tire Changer.

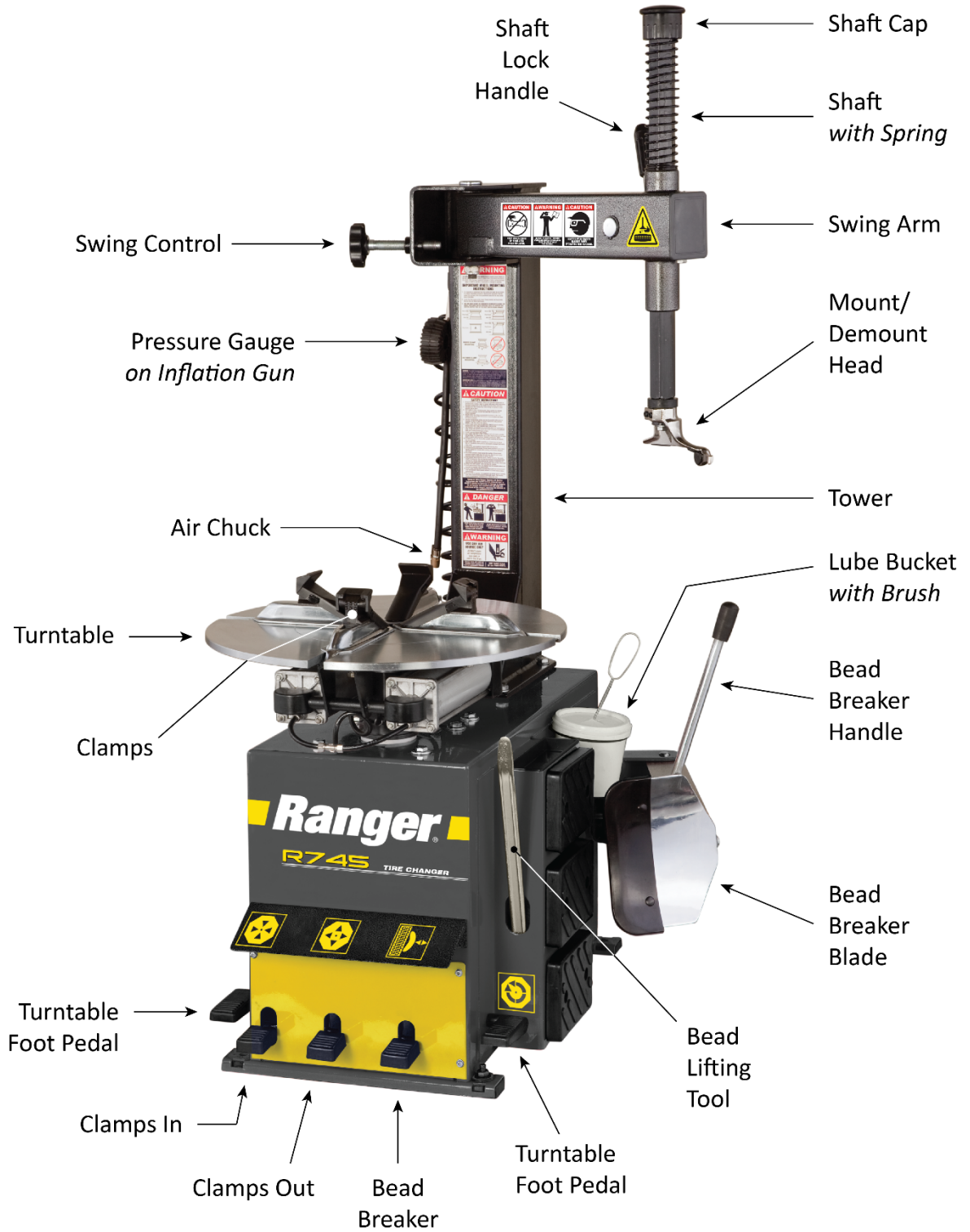

*Not all components visible.*

---

Tire Changer components include:

- **Turntable.** Holds the Wheel and has the Wheel Clamps on it.
- **Wheel Clamps.** Hold the Wheel in place.
- **Tower.** Holds the Swing Arm. Comes uninstalled.
- **Swing Arm.** Holds the main tool, the Mount/Demount Head. Moves to the right up to 90° when not needed or in the way.
- **Mount/Demount Head.** Mounts and demounts Tires. Located on the bottom of the Shaft. The Tire Changer comes with an alloy steel Head. A plastic, non-marring Head is available.
- **Shaft.** Moves up and down; controls the position of the Mount/Demount Head.
- **Shaft Cap.** Moves the Shaft *down* to get the Mount/Demount Head to the desired height.
- **Shaft Lock Handle.** Locks the Swing Arm in the desired position.
- **Swing Control.** Stops the Swing Arm from moving past a specific point you choose.
- **Bead Breaker.** Breaks the Beads of Tires so you can demount them. Located on the right side of the Tire Changer. Includes a Handle a Blade, and a movable mechanism.
- **Bead Lifting Tool.** Basically a Tire Iron that you use to pull the Bead edge of a Tire over the Mount/Demount Head so the Tire can be demounted from the Wheel. Can also be used to hold down a Tire Sidewall during Tire mounting.
- **Inflation Gun with Pressure Gauge.** Adds air to a Tire. The Pressure Gauge shows the amount of air pressure currently in a Tire or the amount of air pressure in a Tire as the Tire is inflated. Includes an Air Chuck with self-gripping clip and an air-dump button.
- **Lube Bucket.** Holds Tire lubricant. Use a lubricant approved by the Tire manufacturer for the Tire being changed.
- **Lube Brush.** Applies the Tire lubricant.
- **Bead Breaker Foot Pedal.** Moves the Bead Breaker Blade in.
- **Clamps In Foot Pedal.** Moves all four Clamps in (if they are out).
- **Clamps Out Foot Pedal.** Moves all four Clamps out (if they are in).
- **Turntable Foot Pedal.** Rotates the Turntable. Press down to rotate the Turntable clockwise, press up to rotate the Turntable counter-clockwise.
- **Regulator/Filter.** Controls the pressure of the incoming air supply and removes water from the incoming air.
- **Lubricator.** Adds lubrication to the incoming air for tools on the Tire Changer that need it.
- **Voltage Switch.** Switches the Tire Changer's motor between 110 VAC and 220 VAC operation. Use with *caution* (refer to [Connecting to Power](#) for detailed information). The Tire Changer comes from the factory set to 110 VAC and the Power Cord has a 110 VAC Plug.
- **Replacement Parts.** Extra Air Line parts, yellow plastic pieces for the Mount/Demount Head, and replacement parts for leaking Foot Pedals, in case they are needed in the future.

---

# Frequently Asked Questions

**Question:** What does a Tire Changer do?

**Answer:** A Tire Changer takes Tires off of Wheels (called demounting), puts Tires onto Wheels (called mounting), and inflates Tires.

**Q:** What is the difference between a Tire, Wheel, and Rim?

**A:** A Wheel is the round **metal** piece that attaches to the Vehicle's axle. A Tire is the round **rubber** piece that surrounds the Wheel. The outer edge of the Wheel, where the Tire attaches to the Wheel, is called the Rim. Some people use Wheel and Rim interchangeably.

**Q:** What are the steps in the process of demounting a Tire and then mounting a new Tire?

**A:** The steps are: Deflate the Tire, break the Bead on both sides of the Tire, secure the Wheel on the Turntable, demount the Tire, mount the new Tire, inflate the new Tire, then remove the Wheel from the Turntable.

**Q:** What does "break the Bead" mean?

**A:** A Tire is held on the Rim of a Wheel by the Tire Bead sitting between the Rim Lip and the Bead Retainer of the Rim (this location is called the Bead Seat). The air pressure in the Tire holds it in place once the Bead is seated (during mounting). When you "break the Bead", you move the Tire Bead out of Bead Seat, which is required to demount the Tire.

**Q:** Can I break the Bead without fully deflating the Tire?

**A:** No, do not do this. *Always **fully deflate** a Tire before attempting to break its Bead.* The air pressure energy in a Tire, even if not fully inflated, can be considerable. If you were to attempt to break the Bead of a Tire not fully deflated, that air pressure energy would be released all at once, possibly injuring or, in rare cases, killing the Operator or bystanders.

**Q:** What thing should I always do when working with the Tire Changer?

**A:** You must identify and correctly match the Tire and Wheel/Rim diameters of the Tires you are mounting; they must match exactly. If they do not match exactly, this is called a tire mismatch. The result of a mismatch is that the Tire could literally explode off the Wheel when you inflate it or while the Vehicle is being driven. In both cases, people could be injured or killed. Note that the phrase "tire mismatch" is also used to mean Tires on a single vehicle with different tread patterns or from different manufacturers. This is not what we are talking about here. BendPak Ranger recommends getting and reading OSHA standard 29 CFR 1910.177 (Servicing Multi-Piece and Single Piece Rim Wheels) for additional information.

**Q:** Where should I put my Tire Changer?

**A:** What you want is a flat Concrete floor with room around it that is also near where you work on Tires. Ideally, you want it a little off the beaten path, as you must – for safety – keep everyone away from the Tire Changer while it is in use. No one other than the Operator should be within 30 feet of the Tire Changer while it is in use.

**Q:** Why is there a 110 VAC plug on the Power Cord; I want to use a 220 VAC power source?

**A:** The Tire Changer comes configured from the factory for 110 VAC. However, it is switchable to 220 VAC. Refer to **Connecting to Power** for complete instructions for switching. Short version: there's a switch on the side that needs to be changed and you need to have an Electrician put a 220 VAC Plug on the end of the Power Cord. Pay careful attention to the instructions for switching; if done wrong, you can damage the Tire Changer.



# Specifications

<b>Model</b>	<b>R745</b>
Motor*	110 <b>or</b> 220 VAC, 50/60 HZ, 1 Ph.
Power Cord Length	120 in (10 feet) / 3,048 mm
Drive System Type	Electric / Air
Air Requirement	140 – 165 PSI (9.6 – 11.4 BAR)
Wheel Clamping	4 Clamps – Internal / External clamping
Table Turning	Dual Pneumatic Cylinders
Bead Breaking	Pneumatic Blade
Tower Design	Rigid Fixed / Swing Arm
Internal Rim Clamping	12 – 21 in / 305 – 533 mm
External Rim Clamping	10 – 18 in / 254 – 457 mm
Turntable Tire Width Capacity	5 – 12 in / 127 – 305 mm
Bead Breaker Tire Width Capacity	3 – 11 in / 76 – 279 mm
Maximum Tire Diameter	39 in / 991 mm
Sound	<70 dB
Dimensions	33 in wide by 39 in deep by 70 in high 838 mm wide by 991 mm deep by 1,778 mm high

- \* Comes from factory configured for 110 VAC operation; can be switched to 220 VAC. Refer to **Connecting to Power** for instructions; Electrician required to switch to 220 VAC.

***Specifications subject to change without notice.***

---

# Installation Checklist

Following are the steps needed to install the Tire Changer. Perform them in the order shown.

- 1. Review the installation Safety Rules.
- 2. Make sure you have the necessary Tools.
- 3. Find an appropriate Location.
- 4. Make sure there is adequate Clearance around and above.
- 5. Unpack the Unit.
- 6. Install the Tower.
- 7. Move the unit to Permanent Location.
- 8. Anchor the Unit.
- 9. Connect to Air.
- 10. Connect to Power (switching to 220 VAC operation **requires** an Electrician)
- 11. Prepare the Lube Bucket.
- 12. Review the Final Checklist.

---

# Installation

This section describes how to install your Tire Changer. Perform the tasks in the order presented.

## Installation Safety Rules

**Pay attention at all times during installation.** Use appropriate tools and equipment. Stay clear of moving parts. Keep hands and fingers away from pinch points. **Safety is your top priority.**

Use caution when unpacking the Tire Changer from its shipping container and setting it up. The Tire Changer is heavy and the weight is not evenly distributed; dropping or knocking over the unit may cause equipment damage and personal injury.

 **WARNING** You **must** wear OSHA-approved (publication 3151) Personal Protective Equipment at all times when installing, using, maintaining, or repairing the Tire Changer: leather gloves, steel-toed work boots, eye protection, back belts, and hearing protection.

Only experienced, trained technicians may install the Tire Changer. In particular, all electrical work **must** be done by a licensed, certified Electrician.

 **CAUTION** Certain parts of installing the Tire Changer are difficult for one person. We **strongly** recommend having two or more persons work together to install the unit.

## Tools

You may need some or all of the following tools:

- Forklift, pallet jack, or shop crane
- Utility knife
- Hammer, mallet, crow bar, or pry bar
- Tin or sheet metal snips
- Hex key and wrench set, metric and SAE
- Screwdriver set, slot and Phillips

## Finding a Location

Keep the following in mind when deciding on a location:

- **Power source.** The Tire Changer needs to be near an appropriate power source.
- **Floor.** The Tire Changer is best used on a flat, Concrete floor.
- **Clearance.** The Tire Changer needs space around it. Refer to **Clearance** for more information.
- **Access.** You need some space to move Tires to and from the Tire Changer.
- **Danger.** When the Tire Changer is in use, especially during Inflation, you need to keep everyone away from it. Only the Operator should be within 30 feet of the Tire Changer when it is in use.  
**Do not set up the Tire Changer in a well-travelled area.**
- **No water.** The Tire Changer has electronic components. If the Tire Changer gets wet while turned on, those electronic components will most likely short circuit and have to be replaced.

 **WARNING** Do not use the Tire Changer if it is in water. You will short circuit the electronic components in the Tire Changer and you could electrocute yourself or bystanders.

## Clearance

A certain amount of space around the Tire Changer is required.

**⚠ WARNING** The Clearance values shown below allow enough space to operate the Tire Changer. **However, for safety purposes, only the Operator should be within 30 feet of the Tire Changer while it is in use.**

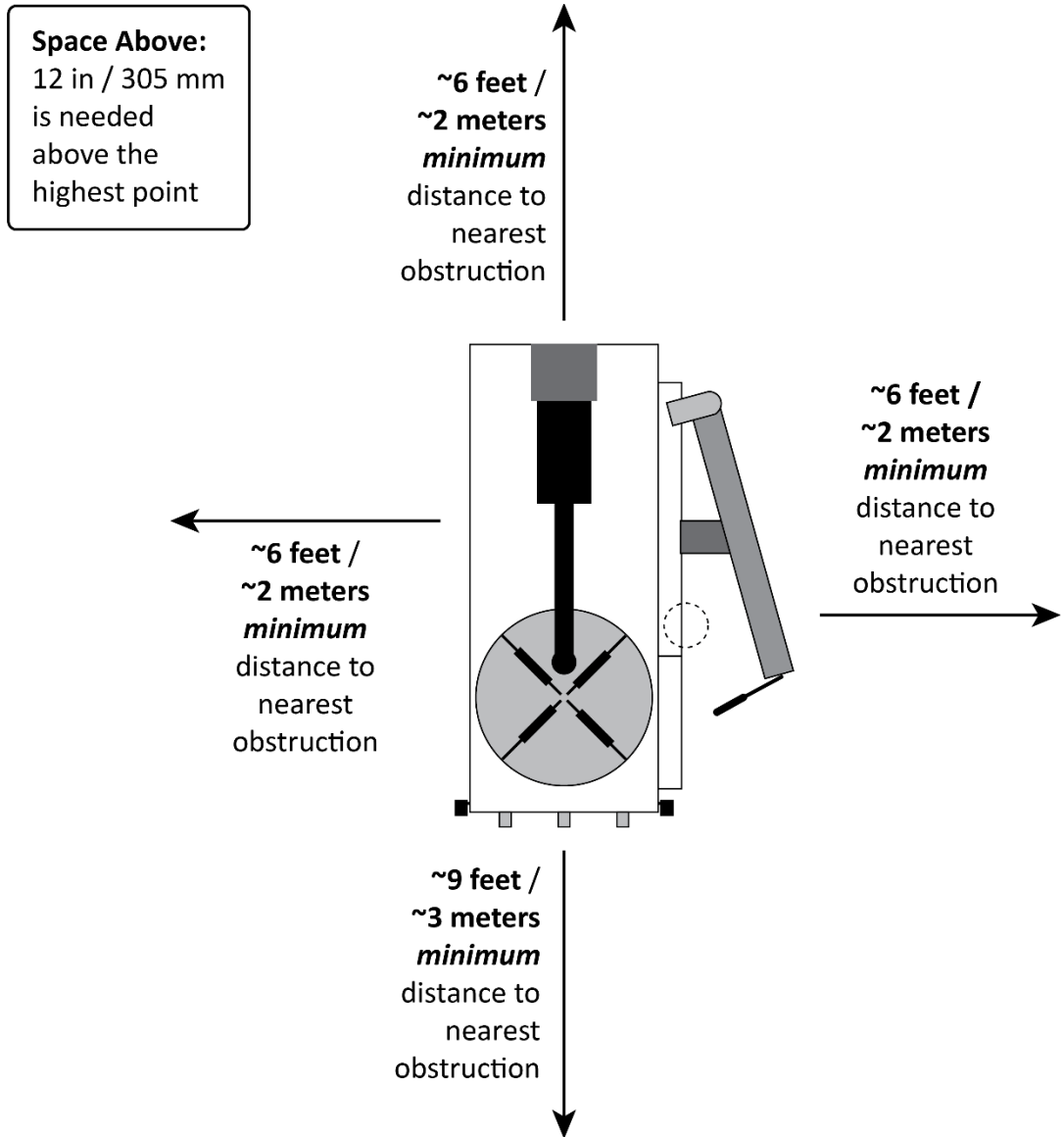

Top view. Not necessarily to scale. Not all components shown.

---

## Unpacking

BendPak Ranger recommends unpacking the Tire Changer as close as possible to its permanent location. The less you have to move things around, the smoother your unpacking and installing will be.

**Note:** Many of the Tire Changer components have been greased for shipping. BendPak Ranger recommends having some rags nearby when unpacking, as you will almost certainly get grease on your gloves. You will probably want to clean the grease off of the Turntable, the Mount/Demount Head, and the Shaft Lock Handle, as keeping them greased would hinder normal operation of the unit. You can keep the Shaft and the Swing Control knob greased.

**Use caution when taking the Tire Changer out of its shipping container.** You do not want to damage the unit, misplace any of the components that come with it, or hurt anyone.

### To unpack the Tire Changer:

1. Make sure you are wearing OSHA-approved (publication 3151) Personal Protective Equipment: leather gloves, steel-toed work boots, back belts, hearing protection, and ANSI-approved eye protection (safety glasses, face shield, or goggles).
2. At the bottom of the Cover, push the metal tabs all the way down, on all four sides.  
You may have to apply some force to get all of the metal tabs free; they sometimes stick.
3. Lift the Cover off.

 **CAUTION** Ranger recommends having at least two people lift the Cover off; it is heavy and awkward. If it is dropped or falls, it could cause injury or equipment damage.

4. Remove the plastic wrap around the Tire Changer and other components.
5. Remove the Accessory Box.

## Installing the Tower

The Tower/Swing Arm comes uninstalled from the factory. You need to remove it from where it is secured on the Shipping Pallet and install it on top of the Tire Changer Cabinet.

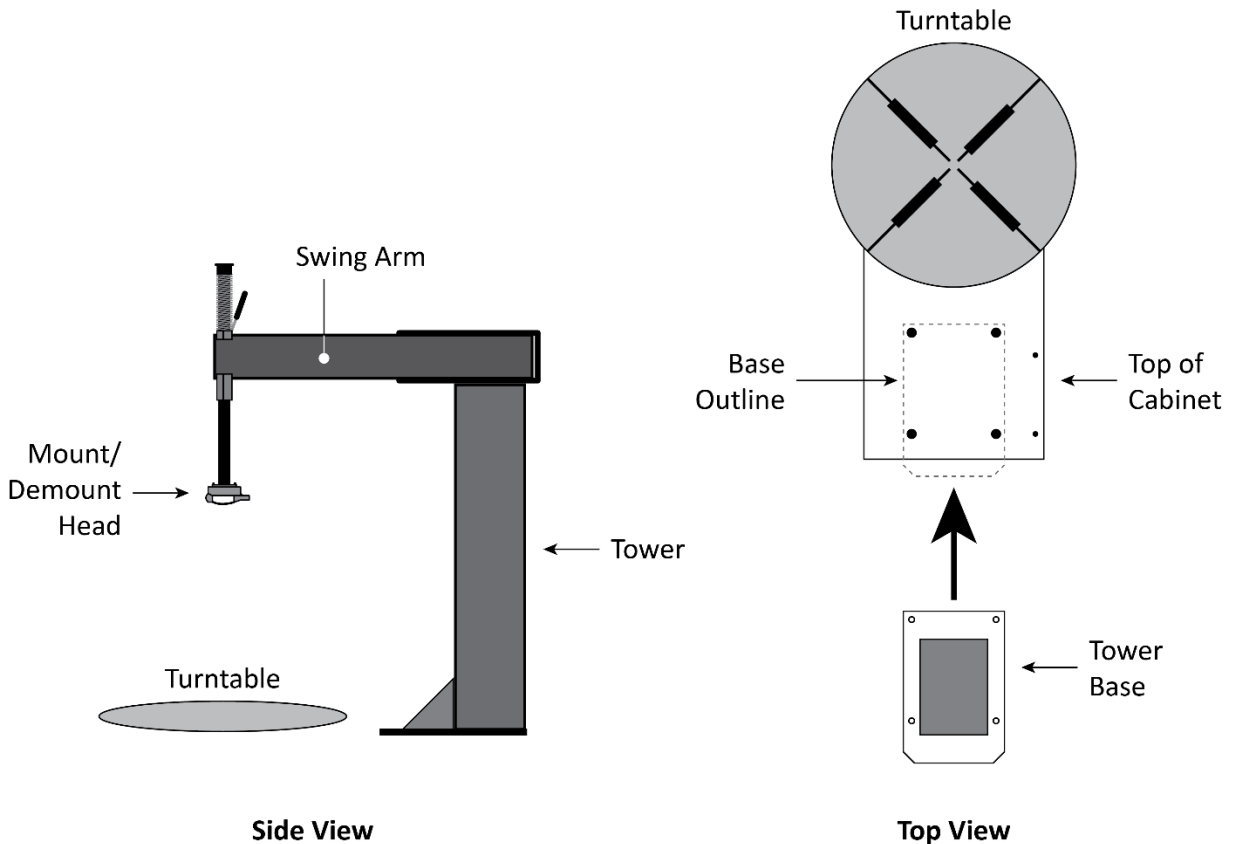

### To install the Tower:

1. Make sure you are wearing OSHA-approved (publication 3151) Personal Protective Equipment: leather gloves, steel-toed work boots, back belts, hearing protection, and ANSI-approved eye protection (safety glasses, face shield, or goggles).
2. **Carefully** remove the components that secured the Tower during transport.  
The Tower comes secured to the shipping pallet in several locations. The Shaft, near the Mount/Demount Head, is tied to a Bolt on the Tire Changer Cabinet.  
Keep the Bolt and Washer that is holding the Shaft; you will need it to complete the installation.
3. Stand up the Tower, then move the Base over the Tire Changer Cabinet, lining up the four holes in the Base over the four large holes in the top of the Cabinet.

**⚠ WARNING** Use care when moving the Tower; it is heavy and not evenly balanced. If it is dropped, you could injure bystanders and damage the unit.

Make sure to orient the Tower so that the Mount/Demount Head is over the Turntable.

There are two smaller holes in the top of the Cabinet; they are not used to install the Tower.

4. Locate the Bolt and Washer that was helping to hold the Shaft during transport.
5. Locate three more Bolt/Washer pairs in a bag in the Accessory Box.
6. Use the four Bolt/Washer pairs to **securely** bolt the Tower into position on top of the Cabinet.

---

## Moving the Tire Changer to its Permanent Location

Once you have installed the Tire Changer's Tower, you can move it to its permanent location.

 **WARNING** Make sure to use an appropriate lifting device, such as a Forklift or Pallet Jack, to move the Tire Changer while it is on its Pallet. Make sure only personnel who are experienced with material handling procedures are allowed to move the Tire Changer. The Tire Changer is heavy and the weight is not evenly distributed; dropping or knocking over the unit may cause equipment damage or personal injury. BendPak Ranger recommends having at least two people work together to move the Tire Changer.

### To move the Tire Changer:

1. Make sure you are wearing OSHA-approved (publication 3151) Personal Protective Equipment: leather gloves, steel-toed work boots, back belts, hearing protection, and ANSI-approved eye protection (safety glasses, face shield, or goggles).
2. Remove the shipping bolts that hold the Tire Changer to the Pallet.
3. Move the Tire Changer off the Pallet.

The Tire Changer can be moved off the Pallet using a Forklift under either side. ***Use care when moving the Tire Changer off the Pallet.***

If you prefer lifting the Tire Changer to move it, install the Main Tower/Swing Arm (described in [Installing the Tower](#)), then use an appropriate lifting device (such as a Shop Crane) with a strap secured around the top of the Main Tower to move it into place.

4. Move the Tire Changer to its permanent location.

## Anchoring the Tire Changer

The Tire Changer has holes for anchoring it in place; anchoring is optional.

**Note:** You are not required to anchor your Tire Changer. BendPak Ranger recommends doing so, as the Tire Changer uses force at various times during the changing of a Tire. Anchoring it ensures it will not move during operation.

The Tire Changer has four .5 in / 12.7 mm holes for anchoring, one at each corner of the base.

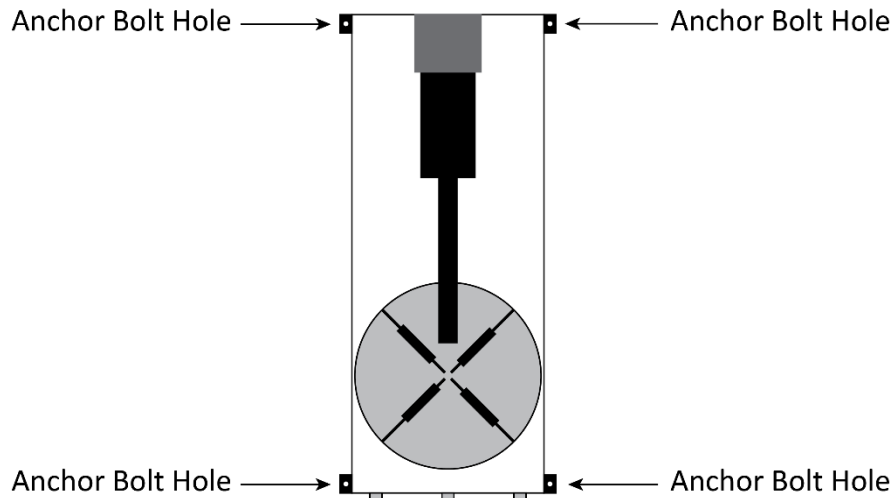

*On the front of the Tire Changer, the Anchor Bolt holes are partially under the Turntable Foot Pedals. Not necessarily to scale. Not all components shown.*

The Anchor Bolts (sometimes called Wedge Anchors) mentioned in the following procedure are **not** supplied with the Tire Changer. You could, for example, use 3/8 in wide by 3 in deep Anchor Bolts to secure the Tire Changer, drilling the hole approximately 2.5 in / 63.5 mm into the Concrete.

### To anchor the Tire Changer:

1. Make sure you are wearing OSHA-approved (publication 3151) Personal Protective Equipment: leather gloves, steel-toed work boots, back belts, hearing protection, and ANSI-approved eye protection (safety glasses, face shield, or goggles).
2. Make sure the Tire Changer is in the desired location.
3. Using the holes as guides, drill the holes for the Anchor Bolts.



Go in straight; do not let the drill wobble. Use a carbide-tipped drill bit (conforming to ANSI B212.15).

Use a drill bit that is the same diameter as the Anchor Bolt. So if you are using an 3/8 in diameter Anchor Bolt, for example, use a 3/8 in diameter drill bit.



- 
4. Vacuum each hole clean.

BendPak recommends using a wire brush and a vacuum to get the hole very clean.

Do **not** ream the hole. Do **not** make the hole any wider than the drill bit made it.

5. Make sure the Washer and Nut are in place, then insert the Anchor Bolt into the hole.

The Expansion Sleeve of the Anchor Bolt may prevent the Anchor Bolt from passing through the hole in the base of the Tire Changer; this is normal. Use a hammer or mallet to get the Expansion Sleeve through the base and down into the hole.



Even using a hammer or mallet, the Anchor Bolt should only go into the hole part of the way; this is normal. If the Anchor Bolt goes all the way in with little or no resistance, the hole is too wide.

Once past the hole in the base, the Anchor Bolt eventually stops going down into the hole as the Expansion Sleeve contacts the sides of the hole; this is normal.

6. Hammer or mallet the Anchor Bolt the rest of the way down into the hole.

Stop when the Washer is snug against the base of the Tire Changer.

7. Use a torque wrench to tighten each Nut **clockwise** to the torque recommended by the manufacturer of the Anchor Bolt.

If no torque is specified, BendPak Ranger recommends ~55 lbf-ft / 74 N-m for a 3/8 in diameter Anchor Bolt.

**Important:** Do **not** use an *impact* wrench to torque the Anchor Bolts.

Wrenching the Nut forces the Wedge up, forcing out the Expansion Sleeve and pressing it tightly against the Concrete.

## Connecting to Air

The Tire Changer requires a 15 to 25 CFM Air Source with an operating air pressure of 140 to 165 PSI (9.6 to 11.4 bar). Connect the Air Source to the Air In connector on the Lubricator/Regulator/Filter, located on the back of the Tire Changer.

**Important:** The Tire Changer uses pneumatic and electrical energy; if your organization has Lockout/Tagout policies, implement them once the unit is connected to the Air Source.

The air lines going out of the Regulator/Filter and Oiler/Lubricator come connected and ready for use; no installation or adjustment is required.

The incoming Air Source connects to the Tire Changer via the Air In connector on the Regulator/Filter. You need to provide a fitting for the Air In connector; it is not supplied.

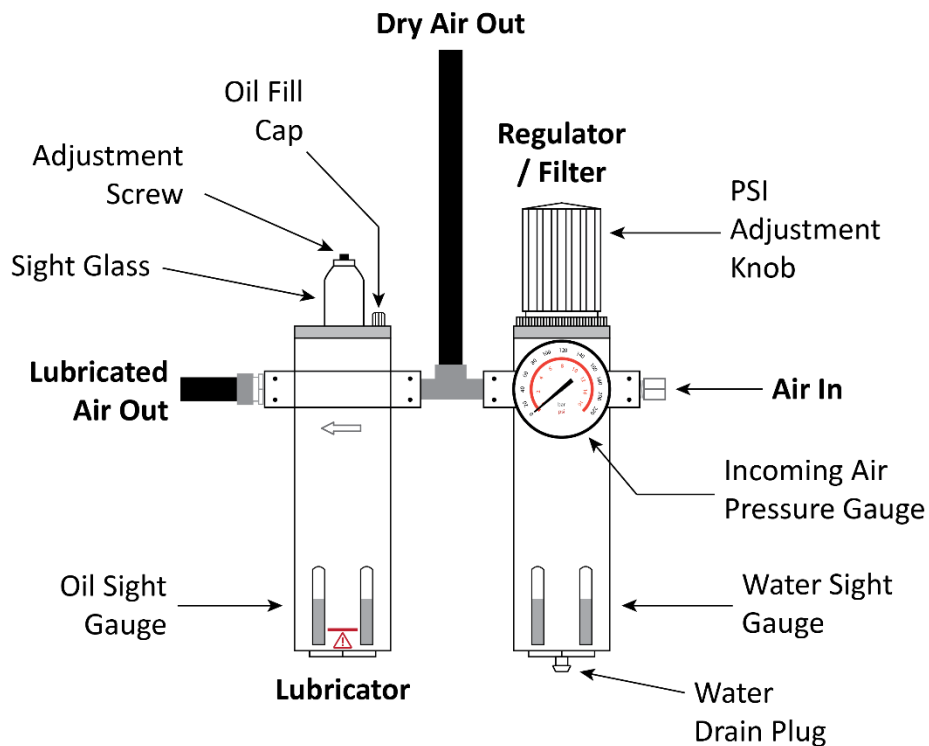

Side view. Drawing not necessarily to scale. Not all components shown.

The following drawing shows a quick-connect air fitting (shown on the right, below) that connects to the Air In connector (shown on the left, below). The fitting is **not** supplied with the Tire Changer.

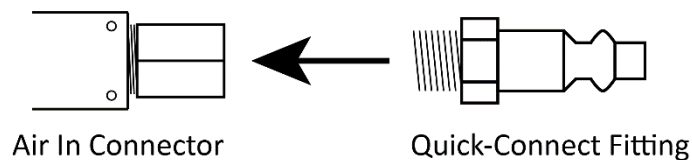

The **Regulator / Filter** removes contaminants from the incoming air. It also includes a gauge that shows the operating air pressure of the incoming air. If you see water in the Water Sight Gauge, you can drain it using the Water Drain Plug. Refer to **Maintenance** for more information.

The **Oiler / Lubricator** puts pneumatic oil, for lubrication, into the incoming air. This lubricated air is routed to pneumatic components of the Tire Changer.

## Connecting to Power

The Tire Changer comes configured for a 110 VAC power source. It can be changed to work with a 220 VAC power source, if desired.

**Important:** The Tire Changer uses pneumatic and electrical energy; if your organization has Lockout/Tagout policies, implement them once the unit is connected to power.

When you receive it from the factory, the Tire Changer is configured for a 110 VAC power source. You can confirm this in two ways:

- **Plug.** The Power Cord has a 110 VAC plug on it.
- **Voltage Switch setting.** The Voltage Switch (on the right side of the unit, behind the Lube Bucket, near the ID Label) is set to the **110V** setting.

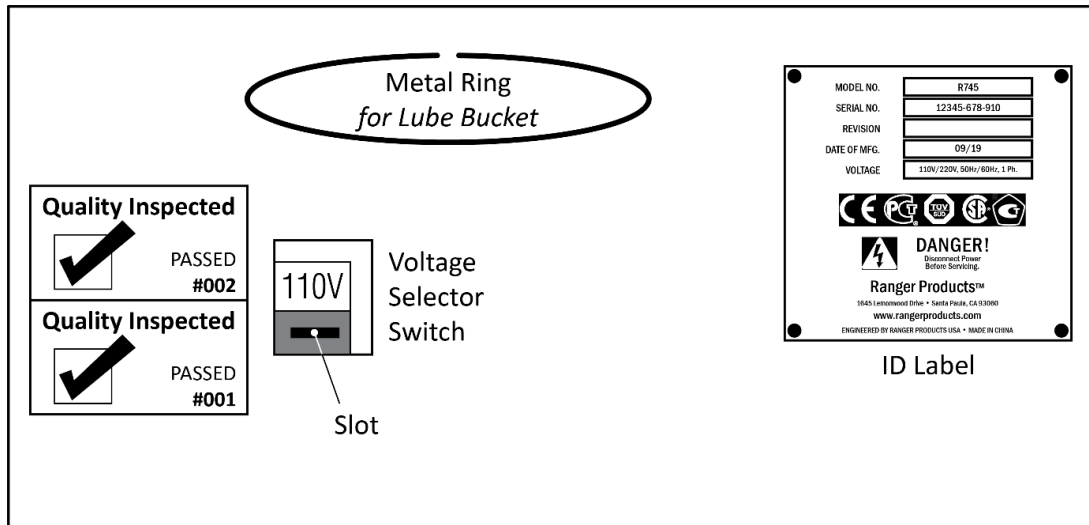

If you want to connect the Tire Changer to a 110 VAC power source, simply plug it in to a 110 VAC power outlet *without changing the setting of the Voltage Switch*. No Electrician is needed to use the Tire Changer with a 110 VAC power source as it comes from the factory.

To connect the Tire Changer to a 220 VAC power source, you need to do two things:

- Change the Voltage Selector Switch to 220 V.
- Change the Plug on the end of the Power Cord to a 220 VAC NEMA 30 Amp Plug.

**⚠ DANGER** *All electrical work (including changing a Plug from 110 VAC to 220 VAC) **must** be done by a licensed, certified Electrician. If you do not use a licensed, certified Electrician, you void your warranty and put everyone who uses the Tire Changer in danger of injury or, in rare cases, death.*

### To switch the Tire Changer to use a 220 VAC power source:

1. Make sure the Tire Changer is **not** plugged in to power or air.

If it is, disconnect it. ***Do not begin to switch the Tire Changer to 220 VAC until you are sure that power and air have been disconnected from the unit.***

2. Cut off the 110 VAC plug on the end of the Power Cord and have an licensed, certified Electrician attach a 220 VAC NEMA 30 amp plug.

Do not change the 110 VAC plug to a 220 VAC plug unless you are a licensed, certified Electrician.

3. Change the setting of the Voltage Selector Switch to **220V**.

This can be done using either your finger or a slot screwdriver.

4. Double check the Voltage Selector Switch to make sure it is set to the **220V** setting.

**⚠ CAUTION** The setting of the Voltage Selector Switch **must** match the power source. If you plug the unit in to 110 VAC power when the Switch is set to 220V or you plug the unit in to 220 VAC power when the Switch is set to 110V, you void your warranty and you could severely damage the Tire Changer.

5. Plug in the Tire Changer to a 220 VAC outlet.
6. Attach the air source to the Tire Changer.
7. Test the unit to make sure air and power are working normally.

Additional electrical information:

- **You must ground the unit.**
- Damage caused by improper electrical installation (not grounding the unit) voids the warranty.

**⚠ WARNING** Disconnect power **before** performing **any** troubleshooting or maintenance. Make sure the unit cannot be reenergized until you are done. This equipment has internal arcing or sparking parts that should not be exposed to flammable vapors. The unit must **not** be located in a recessed area or below floor level.

## Preparing the Lube Bucket

The Tire Changer comes with a Lube Bucket (to hold Lube) and a Lube Brush (to apply Lube).

BendPak Ranger does not include Lube with the Tire Changer, as there are many options available.

**⚠ CAUTION** Only use Tire Lube that is approved by the Tire manufacturer for the Tire you are changing. Using non-approved Lube could corrode the Wheel or cause Tire/Wheel slippage and vibration issues.

Be sure to use enough lubricant without using too much. The point of lubricant is to **temporarily** reduce the friction between the Tire Bead area and the Rim. What you are looking for is a lubricant that is slippery when wet but not slippery once dried. If you notice excessive amounts of lubricant on the Tire or Rim, remove the excess.

There is a location on the Tire Changer for the Lube Bucket: next to the Bead Breaker.

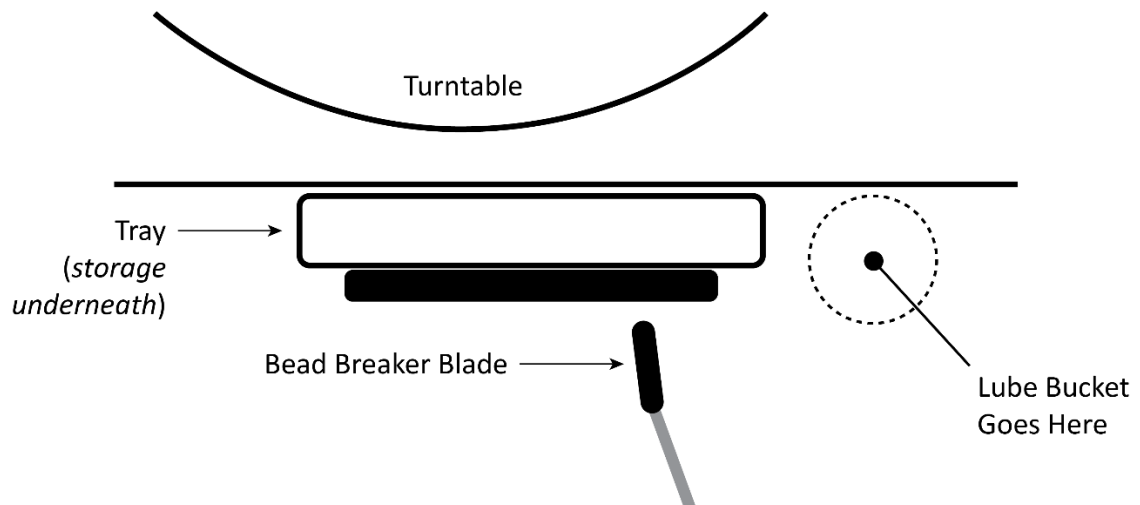

---

## Final Checklist

Make sure the following items have been done **before** putting the Tire Changer into normal operation:

- **Review the Installation Checklist.** Make sure that all of the steps on the **Installation Checklist** have been performed.
- **Check for air pressure.** The Tire Changer requires pneumatic energy to perform certain functions.  
To see if the Tire Changer has air pressure, take the Air Chuck and lightly press and hold down the Trigger of the Inflation Gun. If air comes out, the Air Source is connected and working.
- **Test the power source.** Other Tire Changer functions require electric power. Step on and hold down the Turntable Foot Pedal to check for electric power. If the Turntable turns, you have power.
- **Check the Anchor Bolts.** If the Tire Changer is bolted down, make sure the Anchor Bolts are in position and tightened down.
- **Make sure there is Tire lubricant available.** Your shop probably has a brand of Lube that it prefers. Make sure some is in the Lube Bucket on the Tire Changer. Always use Lube; it makes changing Tires easier and helps prevent damage to the Tire and the Wheel.
- **Change some non-customer Tires.** To get used to the Tire Changer, BendPak Ranger recommends having all potential Operators change *multiple non-customer* Tires before working on customer Tires.
- **Leave the Manual with the owner/operator.** Questions are going to come up that only the Manual can answer. Plus, new Operators will need to study it before starting to change Tires. The Manual needs to be kept near the Tire Changer at all times.

---

# Operation

This section describes how to use your Tire Changer.

It shows and describes the main components involved in demounting and mounting Tires, followed by the necessary procedures for each step in the process.

**⚠ DANGER** Being in close proximity to a Tire Changer is a serious endeavor with potentially life-threatening risks. Only trained, authorized, supervised personnel may be within 30 feet of the Tire Changer while it is in use. ***Do not assume you are going to be safe using the Tire Changer this time just because nothing happened last time.***

## Usage Precautions

Keep the following in mind while you use your Tire Changer:

- Make sure all Operators receive specific training in Tire demounting and mounting ***before*** they are allowed to use the Tire Changer, that their training is verified through a testing program, and that all training is documented. All others, including children and untrained personnel, **must** be kept at least 30 feet away from the Tire Changer while it is in use.
- Make sure new Operators are trained and supervised in the use of the Tire Changer.
- Never perform any service on an *inflated* Tire; ***always*** fully deflate the Tire by removing the Valve Core and letting the air escape before beginning work.
- Never mount or change ***damaged*** Tires or Wheels.
- When mounting Tires, identify the maximum allowed inflation pressure; it should be on the sidewall of the Tire. ***Do not exceed the maximum allowed inflation pressure of the Tire.***
- Make sure the Tire is restrained for inflation: either internally clamped or in a Tire Inflation Cage (such as the **RIC-4716 4-Bar Tire Inflation Cage from BendPak Ranger**). Do not inflate a Tire if it is externally clamped; external clamping interferes with inflation.
- When using the Tire Changer, be careful of your hands; there are multiple pinch point dangers on the unit. ***Do not rest your hands on any part of the Tire Changer while using it.***

**⚠ WARNING** The Air Chuck has a self-gripping clip that lets you clip it on when inflating a Tire, which means you do not have to hold it in place during inflation. ***Do not hold the Air Chuck while you are inflating a Tire.*** This leaves you very close to the Tire, which could result in injury if there were a problem during the inflation. Instead, clip the Air Chuck into position, move away from the Tire, then press and hold down the Trigger on the Inflation Gun.

- You ***must*** wear OSHA-approved (publication 3151) Personal Protective Equipment at all times when installing, using, maintaining, or repairing the Tire Changer. Leather gloves, steel-toed work boots, eye protection, back belts, and hearing protection ***are mandatory.***
- When using the Tire Changer, the operator must wear ***ANSI-approved*** eye protection at all times: safety glasses, a face shield, or protective goggles.

**⚠ WARNING** Always wear ANSI-approved eye protection. An accident could cause significant injuries to your eyes.

- 
- The Tire Changer may work differently than other Tire Changers you have used. BendPak Ranger recommends that Operators practice on multiple non-customer Tires to get familiar with how the product works *before* starting work on customer Tires.
  - Keep the work area clean and well lit. Dirty, cluttered, and dark work areas increase the chances of an accident happening.
  - Do not access the inside of the unit unless instructed to do so by BendPak Ranger Support.

 **WARNING** Be especially careful when inflating Tires. This is a dangerous time when using a Tire Changer. If the Tire and Wheel are mismatched or there is a defect in the Tire, it could explode, injuring or killing the Operator or bystanders. **Do not lean over the Tire when inflating a Tire.** Move away from the Tire during inflation.

- Do not use the Tire Changer in a wet environment or expose it to rain or excess moisture.
- If you need to use an extension cord to get power to the unit, use one with a current rating equal to or greater than that of the Tire Changer. Cords rated for less current than the Tire Changer could overheat. If used, arrange the extension cord so that it will not be tripped over or pulled out.
- Do not use anything flammable on the Beads or Rims as lubrication; instead, use non-flammable vegetable or soap-based rubber lubricant.
- Do not use the Tire Changer in the vicinity of open containers of flammable liquids.
- Clean the unit according to the instructions in **Maintenance**.
- Read the **entire** *Installation and Operation Manual* **before** using the Tire Changer.
- Make a visual inspection of the Tire Changer **before each use**. Do not operate the Tire Changer if you find any issues. Instead, take it out of service, then contact your dealer, visit [www.bendpak.com/support/](http://www.bendpak.com/support/), or call Bendpak Ranger at **(805) 933-9970**.
- Always identify and correctly match the Tire and Rim diameters of the Tires you are mounting; **they must match exactly**. If they do not match exactly, this is called a tire mismatch. The result of a mismatch is that the Tire could literally explode off the Wheel when you inflate it or while the Vehicle is being driven. In both cases, people could be injured or killed.

The phrase “tire mismatch” is also used to mean Tires on a single vehicle with different tread patterns or from different manufacturers. This is not what we are talking about here.

More information is available in OSHA standard 29 CFR 1910.177 (Servicing Multi-Piece and Single Piece Rim Wheels). **All Operators should study this document prior to servicing any Tires.**

## Turntable

The Turntable is where you put the Wheel whose Tire you are demounting or mounting.

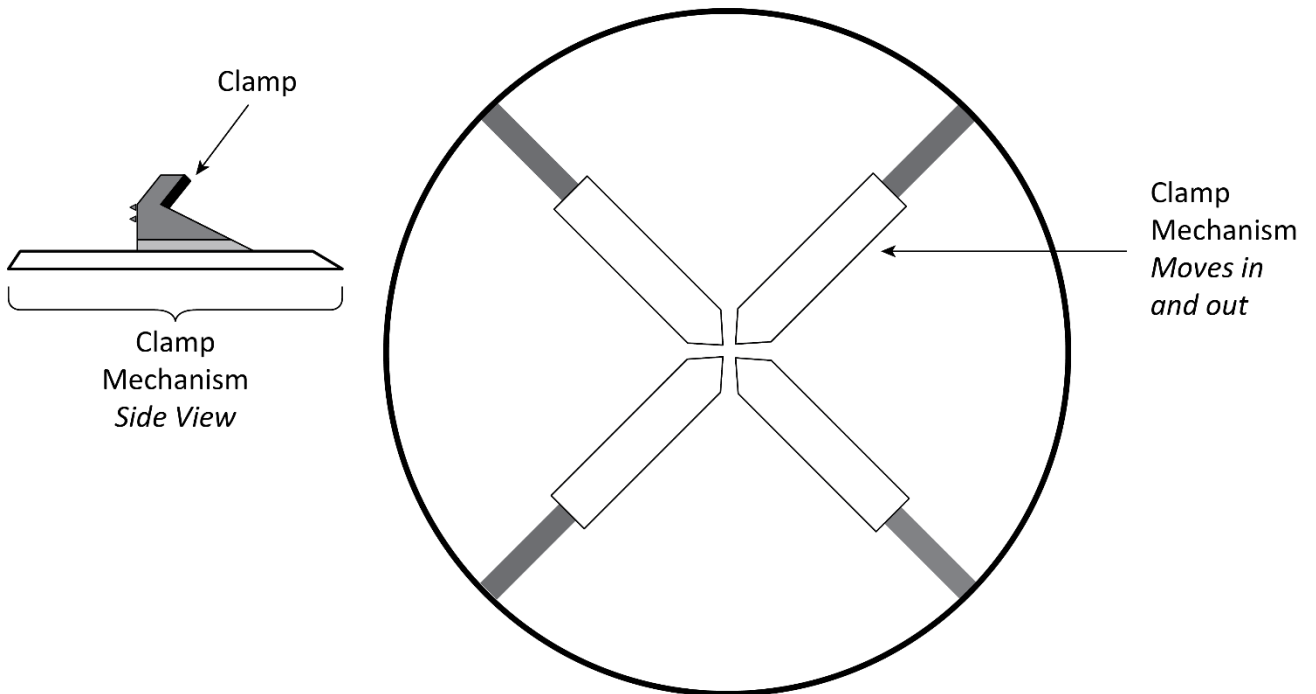

*Top and side views. Not necessarily to scale. Not all components shown.*

The parts of the Turntable are:

- **Flat, round, steel piece.** This is the actual Turntable. It holds the other components. It can rotate either clockwise or counter-clockwise.
  - **To rotate clockwise:** Press **down** and hold down on either Turntable Foot Pedal.
  - **To rotate counter-clockwise:** Press **up** and hold up on either Turntable Foot Pedal.
- **Clamp Mechanism.** Each Clamp mechanism holds a Clamp. The Clamp Mechanism moves in and out to clamp Wheels either externally or internally. All four Clamp Mechanisms move together. They can all be in or they can all be out.

“External” and “Internal” clamping refer to the location of the Clamp in relation to the Wheel.

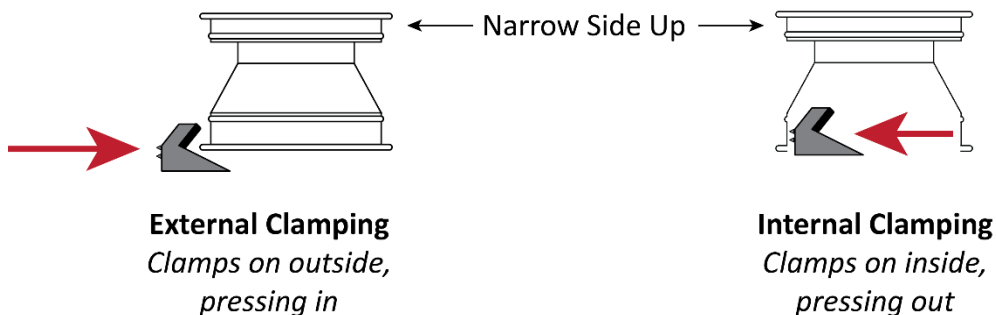

*Side view. Some components exaggerated for clarity. Large arrows show direction Clamps are pressing. Only one of the four Clamps shown. Not necessarily to scale. Not all components shown.*

As a general rule, you clamp steel Wheels internally (Clamps push out against Wheel) and custom and mag Wheels externally (Clamps push in against outside Rim edge). Check with your supervisor if you are unclear about which method to use for a particular set of Wheels.



---

**To clamp externally.** If necessary, press down on the Clamps Out Foot Pedal to move the Clamps **out** (they may be all the way out already, in which case you do not need to move them).

Then, position the Wheel between the Clamps and press down on the Clamps In Foot Pedal to move the Clamps **in** until the Wheel is being firmly held in place.

**To clamp internally.** If necessary, press down on the Clamps In Foot Pedal to move the Clamps **in** (they may be all the way in already, in which case you do not need to move them).

Then, position the Wheel over the Clamps and press down on the Clamps Out Foot Pedal to move the Clamps **out** until the Wheel is being firmly held in place.

## Pedals

The Tire Changer has several Foot Pedals:

- **Turntable Foot Pedals.** Rotate the Turntable. There is one on either side of the front of the Tire Changer.

Press **down and hold down** either Turntable Foot Pedal to go clockwise, press **up and hold up** either Turntable Foot Pedal to go counter-clockwise. When you release the Turntable Foot Pedal, the Turntable stops moving.

The Turntable Foot Pedals work together. If you press down and hold down one of them, the other one also goes down and stays down.

- **Clamps In Foot Pedal.** Press down to move the Clamp Mechanisms in if they are out.

The Clamps In and Clamps Out Foot Pedals are linked. When one is down, the other is up. The one that is down cannot go down any further.

So for example, if the Clamps In Foot Pedal is up, and you press down on it, the Clamps move in and the Clamps In Foot Pedal goes down and stays down. At the same time, the Clamps Out Foot Pedal goes up and stays up.

- **Clamps Out Foot Pedal.** Press and release to move the Clamp Mechanisms out if they are in.
- **Bead Breaker Foot Pedal.** Press down and hold down to move the Bead Breaker Blade in; release the pedal to have the Blade move back out.

At a certain point, the Bead Breaker Blade cannot go any further in. You should release the Bead Breaker Foot Pedal when this happens, whether the Bead is broken or not.

Continuing to hold down the Bead Breaker Foot Pedal when the Blade is all the way in does not help you; the Blade is not going to go any further in.

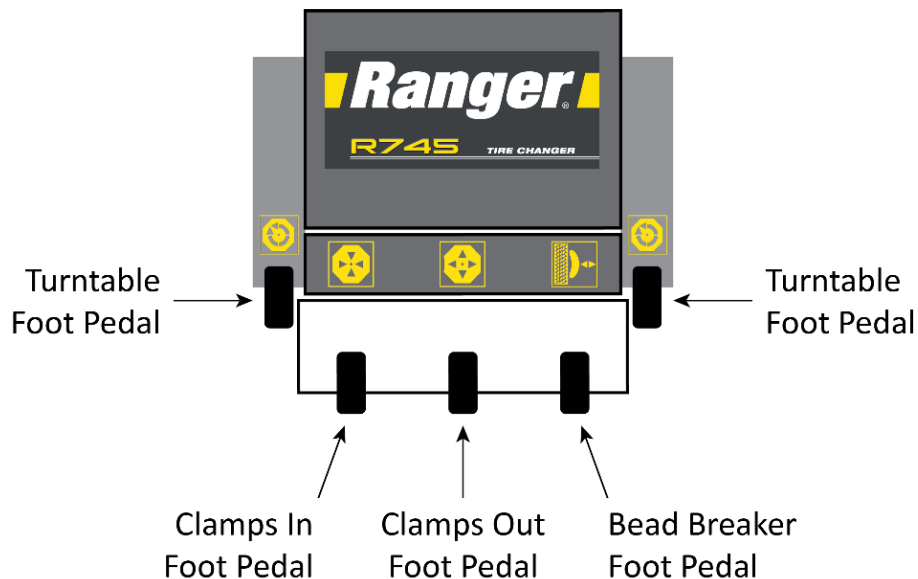

*Front view. Not necessarily to scale. Not all components shown.*

## Inflation Gun

Shows the air pressure in Tires to which the Air Chuck is attached.

There is a hook on the left side of the Tower on which you can hang the Inflation Gun.

The parts of the Inflation Gun are:

- **Air Chuck.** Attaches to the threads on the Valve Stem. Includes a self-gripping clip so you do **not** have to hold the Air Chuck in place during inflation.
- **Pressure Gauge.** Displays air pressure in the Tire to which the Air Chuck is attached.
- **Pressure Relief Button.** Removes air if a Tire gets overinflated.

**⚠ WARNING** **Do not hold the Air Chuck while you are inflating a Tire.** This leaves you too close to the Tire, which could result in injury if there is a problem during inflation.

- **Trigger.** Press and hold to inflate.

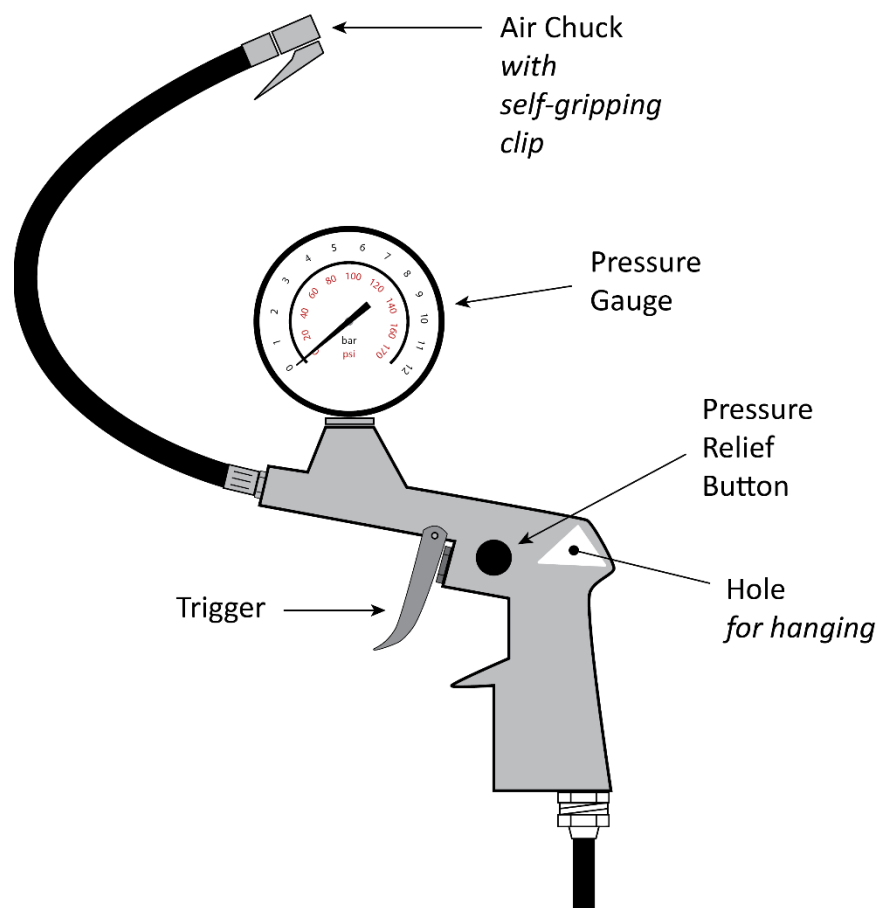

*Side view. Not necessarily to scale. Not all components shown.*

**To see the pressure in a Tire:** Attach the Air Chuck to the Tire's Valve Stem; the Air Gauge shows the air pressure currently in the Tire. You do **not** need to press the Trigger.

**To see pressure during Tire inflation:** Attach the Air Chuck to the Tire's Valve Stem, move away from the Tire, then press the Trigger to inflate the Tire. The Pressure Gauge shows the air pressure in the Tire as it inflates.

## Swing Arm

The Swing Arm holds the main Tire Changer tool, the Mount/Demount Head. It swings out of the way to the right when you do not need it or it is in the way.

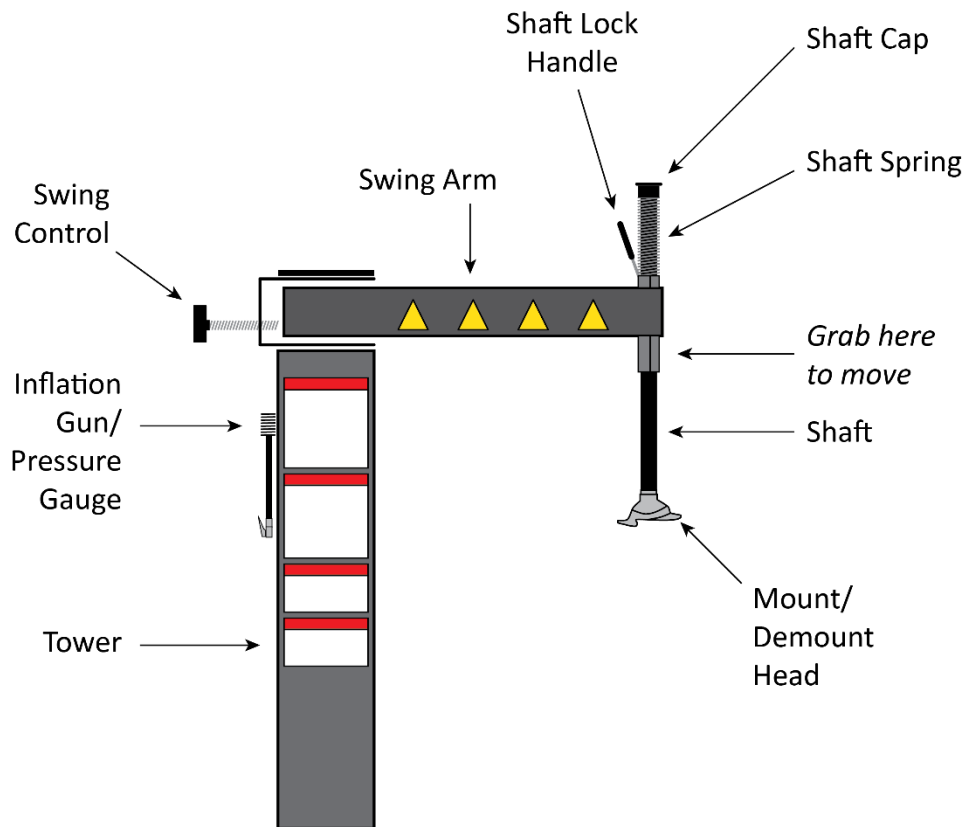

Front view. Swing Arm shown fully to the right. Not necessarily to scale. Not all components shown.

The main parts of the Swing Arm are:

- **Swing Arm.** When facing forward, puts the Mount/Demount Head directly over the middle of the Turntable. From that position, the Swing Arm can swing up to 90° to the right, which lets you get it out of the way when not needed or in the way.
- **Swing Control.** Limits how far the Swing Arm can move back, which lets you position it exactly when you get it to the desired location. Useful if you are going to be working on multiple Wheels that are the same size: move the Mount/Demount Head to the desired location, then adjust the Swing Control so that the Swing Arm returns to this same position if moved out and then back.
- **Mount/Demount Head.** Demounts and mounts Tire Beads.
- **Shaft.** Moves the Mount/Demount Head up and down. Use the Shaft Cap to move the Shaft down. Do not grab the Shaft itself, it is greased.
- **Shaft Cap.** Moves the Shaft down; it moves back up automatically via the Shaft Spring.
- **Shaft Lock Handle.** Locks the Shaft in position.
- **Shaft Spring.** Automatically moves the Shaft and the Mount/Demount Head back up when you release the Shaft Lock Handle.
- **Moving the Swing Arm.** Grab the section of the Shaft just under the Swing Arm to move the Swing Arm left and right. Do not move the Swing Arm using the Shaft or the Shaft Spring.

## Mount/Demount Head

The Mount/Demount Head is the main tool on the Tire Changer for demounting and mounting Tires.

The following drawing shows the Mount/Demount Head with the Demount and Mount Lips identified. It also shows where the Tire Bead goes during demounting and mounting.

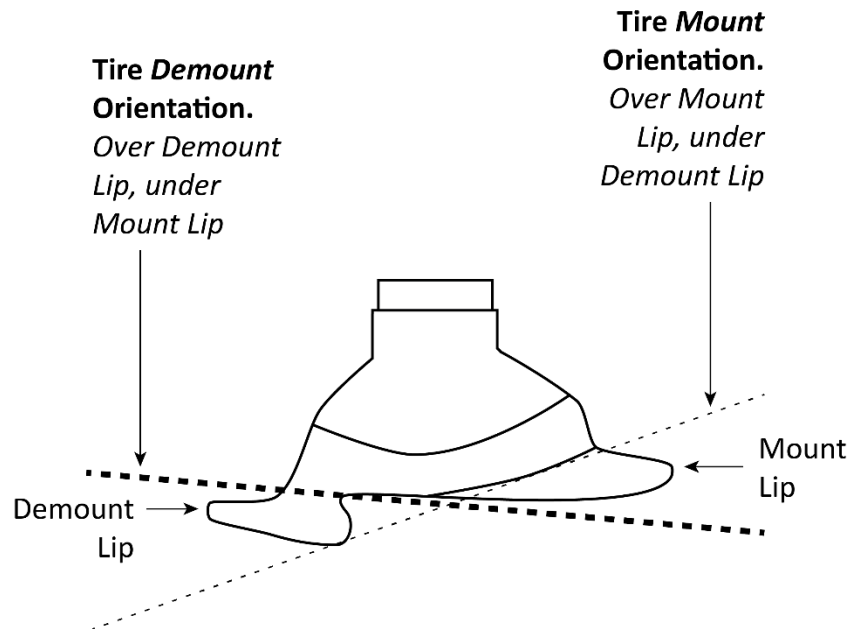

Side view. Not necessarily to scale. Not all components shown.

The Demount Lip and Mount Lip work as follows:

- **During demounting.** The Tire Bead goes **over the Demount Lip** and *under the Mount Lip*.
- **During mounting.** The Tire Bead goes **over the Mount Lip** and *under the Demount Lip*.

The Mount/Demount Head that comes with the Tire Changer is alloy steel, which includes plastic inserts on the inside to avoid damaging Rims.

An optional plastic polymer Mount/Demount Head is available from BendPak Ranger. This Head has a non-marring surface that will not scratch or otherwise damage paint or powder coating on Wheels.

More information about the plastic polymer Mount/Demount Head (5150523) is [available on the BendPak Ranger website](#). Note that a separate Mounting Flange (5150523) is **required**.

If you need to remove the alloy steel Mount/Demount Head to put on the plastic polymer Head, use a 6 mm hex wrench to remove the two set screws, then put on the new Head using the Mounting Flange.

## Bead Breaker

Use the Bead Breaker to break the Beads (on both sides) of the Tires you are demounting.

**⚠ WARNING** **Do not break the Beads of a Tire until you are certain the Tire is fully deflated.** Breaking the Bead of a Tire with air still in it could injure you or others nearby. The best way to be sure the Tire is fully deflated is to remove the Valve Core and wait for all of the air to come out.

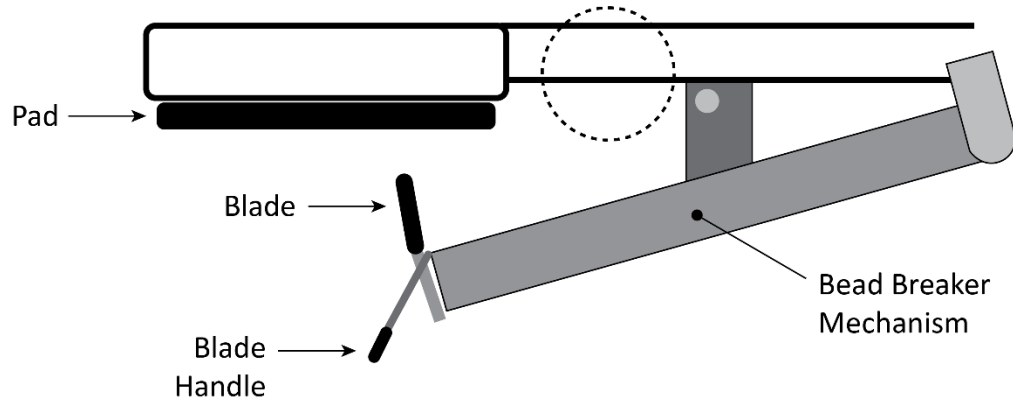

*Top view. Not necessarily to scale. Not all components shown.*

**⚠ WARNING** **There is a risk of crushing with the Bead Breaker.** Do not hold onto the Blade Handle when the Bead Breaker is moving. After positioning the Bead Breaker Blade using the Handle, move away from the Bead Breaker, and make sure the area is completely clear, **before** pressing down on the Bead Breaker Foot Pedal.

The main parts of the Bead Breaker are:

- **Bead Breaker Mechanism.** Moves in and out under the control of the Bead Breaker Foot Pedal. Moves with great force; make sure you are completely clear of the Blade and the Bead Breaker Mechanism **before** pressing down on the Bead Breaker Foot Pedal.
- **Blade.** The part of the Bead Breaker that contacts the Tire and actually breaks the Bead. Make sure to keep the Blade slightly off the Wheel Rim. You could damage the Rim.
- **Blade Handle.** Controls the Blade, moving it side to side and in and out.
- **Pad.** The side of the Tire whose Bead is **not** being broken goes against the Pad.

## Bead Lifting Tool

Use the Bead Lifting Tool to pull the Tire's Bead up and over the Mount/Demount Tool to help demount the Tire.

You can also use the Bead Lifting Tool to push down the Tire's Bead — to the left of the Mount/Demount Head — during the mounting of a Tire.

The Bead Lifting Tool has an angled and a hooked end. You can use either end.



## Before You Change a Tire

**⚠ DANGER** Do not use the Tire Changer unless you have been properly trained and have read the entire *Installation and Operation Manual*. Tire changing must only be done by trained, authorized, supervised personnel. **Failure to understand and follow proper procedures will result in injury or death.**

Before you change a Tire, you should:

- **Remove weights.** Check the Wheel to make sure that all clip-on and adhesive weights (from having the Tire balanced) have been removed.
- **Deflate the Tire.** This is required. **You must fully deflate Tires before demounting them.**

To make sure a Tire is *fully deflated*, remove the Valve Core from the Valve Stem and then wait for all of the air to come out. You should use a Valve Core Tool for this, but if you do not have one, you may be able to use needle-nose pliers.
- **Have Tire lubricant ready.** Tire Lubricant makes the process of demounting and mounting Tires much easier. If you do not use Tire Lubricant, you significantly increase the chances of damaging the Wheel and the Tire. Tire Lubricant is not provided with the Tire Changer.
- **Check for damage.** Especially with expensive Wheels, make sure to check them for any damage *before* changing the Tire. Depending on the circumstances, if you find any damage you might want to discuss that damage with the owner of the Vehicle and/or photograph the damage. If you work in a shop, talk to your supervisor regarding shop policies in this area.

Additionally, damaged Wheels and Tires are dangerous to work with. If you are not sure whether a Wheel or Tire is too damaged to service, talk to your supervisor.
- **Understand Performance Wheels.** Before servicing performance Wheels, review the Performance Wheels section of this manual.
- **Identify the Narrow Side/Drop Center of the Wheel.** The rule is: the Narrow Side/Drop Center side of the Wheel gets put onto the Tire Changer facing up. For most Wheels, this means the side of the Wheel facing the *outside* of the Vehicle goes on top, because that's where the Narrow Side/Drop Center side is on most (but not all) Wheels.

The following drawing shows two Wheels and identifies the Narrow Side, Drop Center, and Wide Side of each.

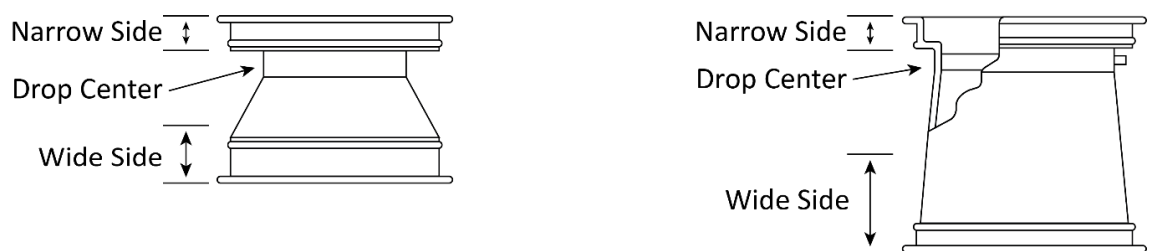

Some aftermarket and OEM performance Wheels are **reverse** drop-center Wheels, meaning the Narrow Side/Drop Center side of the Wheel is closer to the *inside* of the Vehicle. The rule still holds for these Vehicles: the Narrow Side/Drop Center side of the Wheel gets put onto the Tire Changer facing up.

- **Ask your Supervisor.** If you have any concerns about a Tire you have been asked to demount or mount, or about how to use the Tire Changer, talk with your Supervisor **before** starting work.

---

## Working with Custom and Special Wheels

This section covers working with Alloy Wheels with no drop center, European performance Wheels, and Wheels with tire pressure monitoring systems.

### ***Alloy Wheels***

Some manufacturers offer Wheels with little or no drop center. These types of Wheels are almost never Department of Transportation approved.

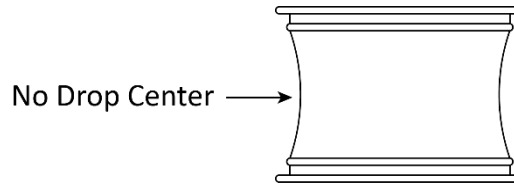

**⚠ DANGER** The Tire, Wheel, or both can be damaged and the Tire could explode under pressure, resulting in serious injury or death. ***BendPak Ranger recommends you not try to demount or mount this type of Wheel.*** If you do attempt to demount or mount this type of Wheel, **proceed with extreme caution.**

### ***European Performance Wheels***

Some European performance Wheels have very large humps except near the Valve Hole.

On these Wheels, the Beads should be loosened at the Valve Hole on both the upper and lower sides first.

### ***Wheels with Tire Pressure Monitoring Systems (TPMS)***

Some Wheels have a pressure sensor located behind the Valve Stem. On these Wheels, the Beads should be broken opposite the Valve Stem on both upper and lower sides first, before breaking the Beads on the rest of the Tire.

Performance Wheels on some Vehicles have a pressure sensor strapped to the Rim opposite the Valve Hole. On these Wheels, the Beads should be loosened at the Valve Hole on both the upper and lower sides first, before breaking the Beads on the rest of the Tire.

Be mindful of the TPMS sensor when breaking a Tire's Bead, demounting a Tire, and mounting a new Tire. If your shop does not have specific recommendations for handling these situations, BendPak Ranger recommends:

- **When breaking a Tire's Bead.** Keep the TPMS sensor away from where the Bead is being broken. Put the sensor at 12 o'clock high (relative to the ground) when breaking the Bead.
- **When demounting a Tire.** Put the TPMS sensor just to the right of the Mount/Demount Head.
- **When mounting a Tire.** Put the TPMS sensor just to the left of the Mount/Demount Head.

These are general guidelines; be sure to use common sense and take into consideration the specifics of each situation. Talk to your Supervisor if you are still unsure.

When finished mounting a Tire with a TPMS sensor, check that it is working. It is against the law to knowingly not re-install a working TPMS if the Vehicle arrived at the facility with a functioning TPMS. If it came in with a functioning TPMS, it needs to leave with a functioning TPMS.



---

## The Steps in Changing a Tire

Before you start working on a Tire, review the requirements in [Before You Change a Tire](#).

Changing a Tire consists of multiple steps:

1. **Deflate the Tire.** There is a lot of energy stored in a Tire when it is inflated. You **must fully** deflate the Tire before you can demount it. If you do not, that energy will be released when you try to demount it, which could result in the Tire exploding, causing injury and even death to the Operator or bystanders. **Never work on a Tire unless you have personally confirmed that it is fully deflated.** The best way to do this is to make sure the Valve Core has been removed from the Valve Stem and the air has had time to come out.
2. **Break the Bead.** Tires stay in position because the Tire Bead is seated between the Bead Retainer and the Rim Lip of the Wheel (called the Bead Seat). To demount a Tire, you must get the Bead out of the Bead Seat all the way around **both sides** of the Tire. This is called Breaking the Bead. Use care when Breaking the Bead of Wheels with a TPMS.
3. **Secure the Wheel on the Turntable.** It is important for the Wheel to stay in place on the Turntable. The Tire Changer supports both Internal and External Clamping.
4. **Demount the Tire.** Once the Bead is broken, you still have to slide both Beads over the Rim Lip of the Wheel to get it fully off. Once the Tire is demounted from the Wheel, you can move it out of the way and then mount the new Tire.
5. **Mount the Tire.** Mounting a Tire is basically the opposite of demounting. You first need to get the Beads under the Rim (the opposite of demounting the Tire), get the Beads into position **in** the Bead Seats (the opposite of Breaking the Bead), and then inflate the Tire (the opposite of deflating the Tire).
6. **Inflate the Tire.** Three separate stages: Bead Seal, Bead Seat, Inflate. **Bead Sealing** is putting in a small amount of air pressure to push the Tire up against the Rim so that no more air leaks out. **Bead Seating** is putting in more air pressure to “pop” the Beads into position in the Bead Seats. **Inflation** is adding air pressure to the Tire manufacturer’s recommended pressure after the Beads have been seated.

Do not inflate a Tire if it is *externally* clamped; external clamping interferes with inflation.

7. **Remove the Wheel from the Turntable.** Disengage the Clamps, then move the Wheel and Tire off the Turntable and back onto the ground.

---

## About Valve Stems

The following drawing shows a Valve Stem and its components.

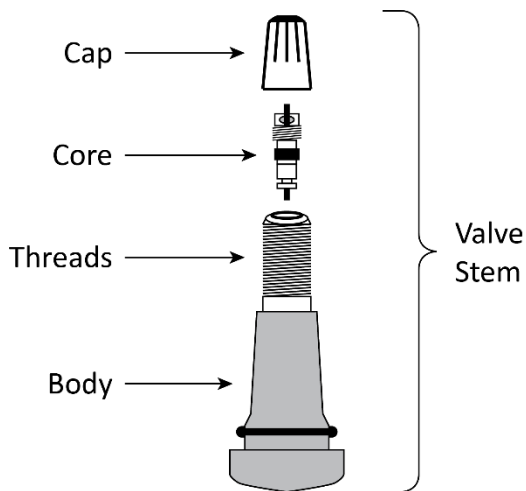

This manual talks about Valve Cores and Valve Stems at multiple points:

- **When demounting a Tire.** Taking out the Valve Core lets the air out of the Tire, which **must** be done before you can demount a Tire.  
It is dangerous to do any service on a Tire if there is air still in it.  
There is a tool called a Valve Core Tool that makes it easy to remove a Valve Core.
- **When replacing the entire Valve Stem.** Valve Stems are normally replaced when you mount a **new** Tire on a Wheel.

When mounting a new Tire, BendPak Ranger recommends installing a new Valve Stem, but it is not required. The process for replacing a Valve Stem is to cut out or pull out the old Valve Stem, then install the new Valve Stem. This should be done after the old Tire has been demounted but before the new Tire is mounted.

There is a tool called a Valve Stem Installer/Remover Tool (sometimes Valve Stem Puller/Remover Tool) that can be used to both remove an old Valve Stem and install a new Valve Stem.

This tool is **not** the same tool as the Valve Core Tool.

- **When inflating a Tire.** Before starting the first stage of inflating a Tire (sealing the Beads), remove the Valve Core. **Make sure to keep it.** Removing the Valve Core allows air to move more easily into the Tire.  
Once the *second* stage of inflating a Tire (seating the Beads) is *complete*, put the Valve Core back in.

Sealing and seating the Beads do not put too much air pressure into the Tires. Inflating the Tire, the third stage, does. So you want the Valve Core in for the inflation stage, as that will keep the air from coming back out of the Tire.

You can put the Valve Core back in after inflation, but air will be coming out as you do, so you will need to put that air back in again once the Valve Core is in.

---

## Deflate the Tire

You must **fully deflate** a Tire before you can demount it.

**⚠ DANGER** Never attempt to demount or mount an **inflated** Tire. They **must** be deflated. Attempting to demount or mount an inflated Tire could cause it to explode, which could result in injury or even death.

### To deflate a Tire:

1. If the Valve Stem has a Cap on it, remove the Cap.
2. Pull the Valve Core out of the Body.

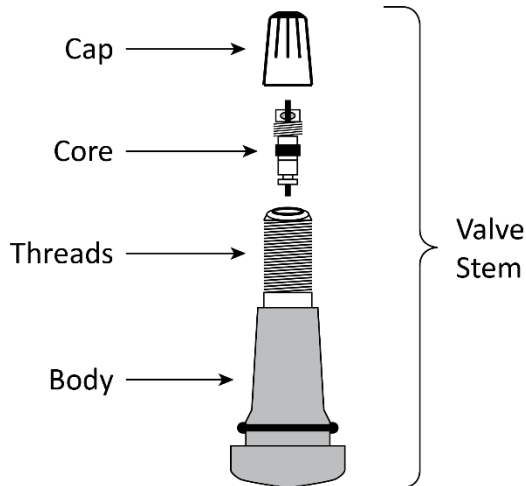

Use a Valve Core Tool to remove the Valve Core. If a tool is not available, you may be able to use needle-nose pliers.

If you are going to use the same Valve Stem with the new Tire you are going to mount, keep the Valve Core you just took out.

BendPak Ranger recommends installing a new Valve Stem when you mount a Tire.

3. Make sure all of the air comes out of the Tire.

**⚠ WARNING** Do not proceed with any other Tire changing activity until you are certain the Tire is **fully** deflated. Do not demount a Tire until you yourself have made sure the Tire is fully deflated. In other words, do not take someone's word for it. If you are demounting a Tire, **you** must make sure it is **fully** deflated.

---

## Break the Beads

The Beads must be broken – on both sides of a Tire – before the Tire can be demounted.

**⚠ WARNING** Do not Break the Bead of a Tire until **you** have made sure the Tire is fully deflated. A Tire with air still in it could explode, injuring the Operator or bystanders.

The Bead is broken when the Tire Beads come out from between the Rim Lip and the Bead Retainer (the Bead Seat) all the way around the Tire, on **both** sides of the Tire.

### To break a Tire's Beads:

1. Make sure you are wearing OSHA-approved (publication 3151) Personal Protective Equipment: leather gloves, steel-toed work boots, back belts, hearing protection, and ANSI-approved eye protection (safety glasses, face shield, or goggles).
2. Check the Tire again to make sure it is **fully** deflated.
3. Check both sides of the Tire to make sure all Wheel weights (from balancing) have been removed. If they have not, remove them.

**⚠ CAUTION** Breaking the Beads of a Tire with Wheel weights could damage the Tire Changer and/or the Wheel.

4. Identify the Narrow side of the Tire whose Beads you are breaking; break this side first.
5. Move the Tire into position between the Pad and the Bead Breaker Blade, with the Narrow side of the Tire on the Blade side.
6. If you are Breaking the Beads of a Tire with a TPMS, put the sensor at 12 o'clock high or 6 o'clock low (relative to the ground), to reduce the chances of damaging it.



7. Move the Blade so that it is on the side of the Tire, very close to, **but not touching**, the Rim.

---

 **CAUTION** Make sure the Blade is **not** touching the Rim. The Bead Breaker Mechanism uses a great deal of force; the Rim could be damaged if the Blade pushes on it instead of the side of the Tire.

8. Step on and hold down the Bead Breaker Foot Pedal.

The Blade pushes in, moving the Bead out of the Bead Seat and in towards the Drop Center of the Tire.

When the Bead breaks, it frequently (but not always) makes a popping sound.

9. Release the Bead Breaker Foot Pedal when the Blade goes all the way in or the Bead is broken.

10. If the Blade does not fully break the Bead, adjust the Tire and/or the Blade a little bit one way or the other and then step on and hold down the Bead Breaker Foot Pedal again.

It may take several attempts to fully break the Bead.

11. When the Bead is broken at the current location, rotate the Tire 180° and break the Bead at that location.

**Important:** Every Tire is different. With some Tires, the entire Bead on one side could be broken with the first use of the Bead Breaker Blade. Other Tires could take multiple attempts until the Bead is broken all of the way around the Tire.

12. When the Bead is completely broken all the way around on one side of the Tire, move the Tire out, turn it around, and then break the Bead on the other side of the Tire.

Again, avoid breaking the Bead at the TPMS; you could damage the sensor.

**Important:** It may take you two or three times to break the Bead at any one spot. Nevertheless, keep going until you break the Bead all the way around the Tire and on both sides of the Tire.

 **WARNING** Do **not** proceed to demounting the Tire until the Bead is broken **all the way around** the Tire and on **both sides** of the Tire.

---

## Secure the Wheel on the Turntable

Before you can demount a Tire, you must secure the Wheel on the Turntable.

The Tire Changer supports two ways of securing a Wheel:

- **External clamping.** The Clamps are on the outside of the Tire's Rim, pressing inwards.
- **Internal clamping.** The Clamps are on the inside of the Tire's Rim, pressing outwards.

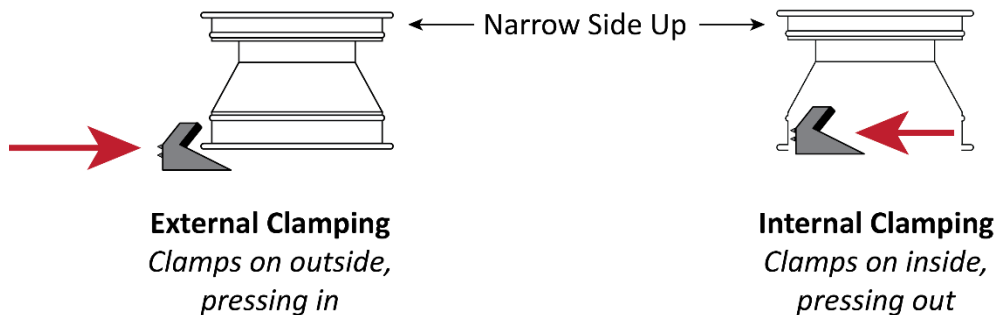

As a general rule, steel Wheels clamp internally and custom and mag Wheels clamp externally. Check with your supervisor if you are unclear about which method to use for a particular Wheel.

### To secure a Wheel on the Turntable:

1. Make sure you are wearing OSHA-approved (publication 3151) Personal Protective Equipment: leather gloves, steel-toed work boots, back belts, hearing protection, and ANSI-approved eye protection (safety glasses, face shield, or goggles).
2. Identify the Narrow side of the Tire; this side goes up.
3. Determine which clamping method you are going to use.
  - If you are clamping externally, move the Clamps all the way **out**.
  - If you are clamping internally, move the Clamps all the way **in**.
4. Put the Wheel onto the Turntable, either between the Clamps that are all the way out for external clamping or over the Clamps that are all the way in for internal clamping.
5. Secure the Wheel:
  - If you are clamping externally, move the Clamps **in** until the Wheel is being held firmly in place.
  - If you are clamping internally, move the Clamps **out** until the Wheel is being held in place.



### Tip

Clamping externally can be difficult with some Tires. If you are having problems getting the Clamps to clamp externally, press down on the Wheel from above. Pushing down from above moves the Rim away from the Tire a little, making it a little easier for the Clamps to grab the Rim.

## Demount the Tire

Demounting a Tire is the process of taking a Tire off a Wheel. Specifically, you need to pull the top Bead over the **top** of the Rim, then pull the bottom Bead also over the **top** of the Rim.

**⚠ CAUTION** You **must** use Tire lubricant; this makes the Tire demount more easily and helps to prevent damage to the Wheel and/or the Tire.

During demounting, the Bead goes over the Demount Lip of the Mount/Demount Head but stays under the Mount Lip. See **Mount/Demount Head** for additional information.

**⚠ WARNING** The following procedure **requires** that the Tire's Beads are broken on **both** sides. **Do not** try to demount a Tire whose Beads are not broken on both sides; you could damage the Wheel, the Tire, or injure yourself or bystanders.

### To demount a Tire:

1. Make sure you are wearing OSHA-approved (publication 3151) Personal Protective Equipment: leather gloves, steel-toed work boots, back belts, hearing protection, and ANSI-approved eye protection (safety glasses, face shield, or goggles).
2. Verify that the Tire's Beads are completely broken on both sides of the Tire.
3. Apply Tire lubricant to both the top and bottom Tire Beads and the top Rim.  
This helps slide the Beads over the top Rim more easily.
4. Move the Mount/Demount Head into position, very close to the Rim **but not touching it**, and lock it in position using the Shaft Lock Handle.



### Tip

If you are working on multiple Wheels of exactly the same size, you can “lock” the Mount/Demount Head to this location using the Swing Control, located next to the Swing Arm at the top of the Tire Changer. Refer to **Swing Arm** for more information.

At this point, the top Bead is under both the Mount Lip and the Demount Lip.

5. Push the top Bead 180° **opposite** the Mount/Demount Head into the Drop Center of the Wheel.  
This gives you some extra room to help pull the top Bead over the Demount Lip.

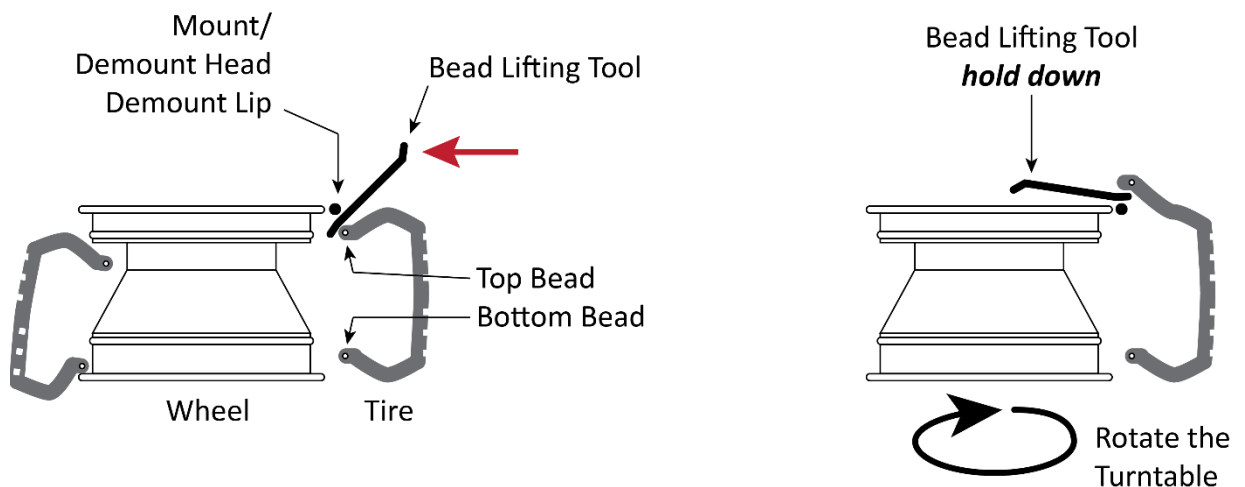

Side view. Not necessarily to scale.

6. Take the Bead Lifting Tool, position one end on the outside of the Demount Lip of the Mount/Demount Head, then slide it down between the Demount Lip and the top Tire Bead until it is just past (and a little under) the Bead.
7. Carefully push the Bead Lifting Tool in towards the other side of the Wheel in an arc.  
This pulls the top Bead over the Demount Lip, which is what you want.

**Top Bead Demount Orientation.**

*Top Bead over Demount Lip,  
under Mount Lip*

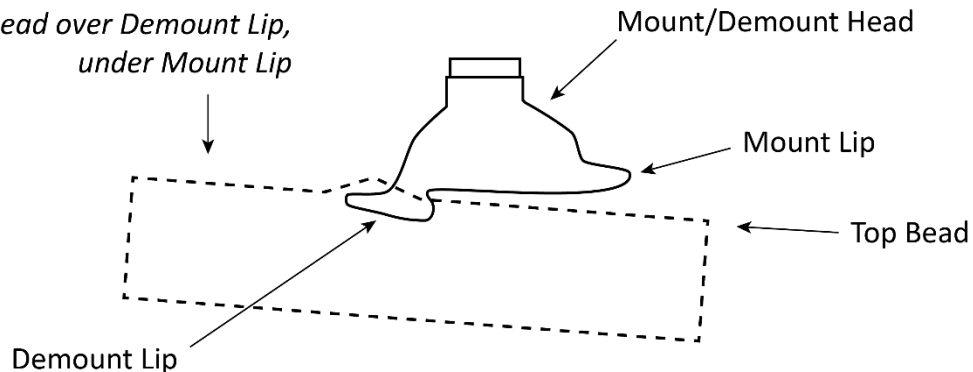

**⚠ CAUTION** **Hold on to the Bead Lifting Tool.** Depending on the Tire, it may take a good deal of force to move the Bead up and over the Demount Lip. If you were to release the Bead Lifting Tool at this point, it could easily injure the Operator or damage the Wheel, Tire, or the Tire Changer.

Check to make sure the Bead Lifting Tool is lifting the Tire Bead up and over the Demount Lip of the Mount/Demount Head. If the Tire Bead is **not** coming up and over the Demount Lip, pull the Bead Lifting Tool out and start again.

8. When the Bead Lifting Tool has moved all the way over and is lying flat, check the top Bead to make sure it is above the Demount Lip.

The top Bead **must** be above the top of the Demount Lip to proceed.

*Continue holding the Bead Lifting Tool.*

9. Press down the Turntable Foot Pedal so that the Turntable begins turning clockwise.

**Note:** If you have difficulty getting the Turntable to move clockwise, release the Turntable Foot Pedal, keep hold of the Bead Lifting Tool, and then press up on the Turntable Foot Pedal for few seconds to move the Turntable counterclockwise, then press down again to move clockwise. Repeat as necessary to clear up the difficulty.

Watch the top Bead to make sure it is being pushed over the Rim, all the way around the Tire, as the Turntable moves.

10. Keep turning the Turntable until the entire top Bead pops over the top of the Rim.
11. When the top Tire Bead pops over the Rim, release the Turntable Foot Pedal and remove the Bead Lifting Tool.  
The top Bead is demounted.  
The next step is to demount the bottom Bead over the top Rim.
12. Make sure there is still lubricant on the bottom Bead and the top Rim.  
If there is not, put some more on.



13. Push the bottom Bead up as much as possible all the way around the Wheel, then push the side of the Tire opposite the Mount/Demount Head into the Drop Center of the Wheel.
14. Take the Bead Lifting Tool, put it on the outside of the Demount Lip, then slide it down past and under the bottom Bead.

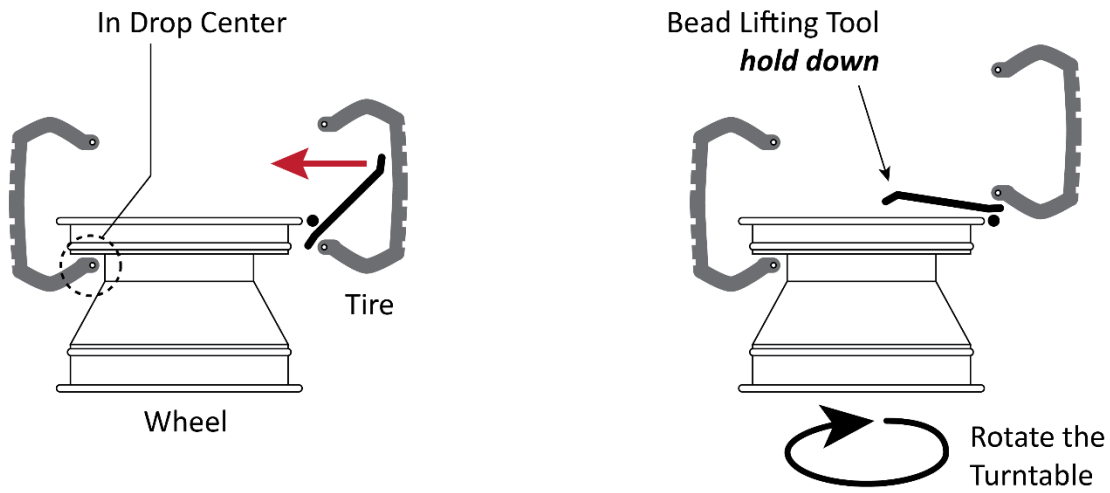

*Side view. Not necessarily to scale.*

Getting the Bead Lifting Tool into position may be trickier this time, as the rest of the Tire is in the way as you are trying to get access to the bottom Bead.

#### **Bottom Bead Demount Orientation.**

*Bottom Bead over Demount Lip,  
under Mount Lip*

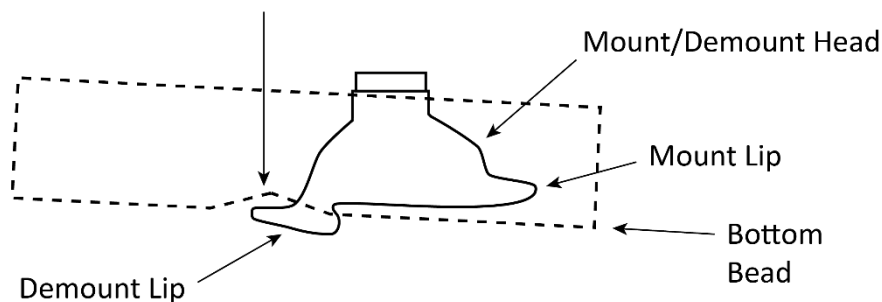

*Side view. Not necessarily to scale.*

15. Push the Bead Lifting Tool towards the other side of the Wheel in an arc, pulling the bottom Bead over the Demount Lip of the Mount/Demount Head.
16. While continuing to hold the Bead Lifting Tool, press down on the Turntable Foot Pedal to move the Turntable clockwise.  
  
Watch the bottom Bead to make sure it is being pushed over the top of the Rim as the Turntable moves.
17. Keep turning the Turntable until the entire bottom Bead pops over the top Rim.  
  
The Tire is now dismounted and can be removed.

---

## Wheel / Tire Mismatches

A Wheel / Tire mismatch is mounting a Tire where the Tire's Bead diameter does not exactly match the Diameter of the Wheel/Rim.

**⚠ DANGER** **A Wheel / Tire mismatch is extremely dangerous.** A mismatched Tire and Wheel may separate or explode, resulting in injury or death.

The differences can be subtle, so you must take care to get an **exact match**.

For example, a 16 inch Tire goes on a 16 inch Wheel, not a 15.5 or a 16.5 inch Wheel. It may be possible to slide the 16 inch Tire over the Rim Lip of a 16.5 inch Wheel, but during inflation it will **not** seat properly.

**⚠ WARNING** **Do not** mount a Tire on a Wheel until you, **yourself**, have positively identified and correctly matched the Tire and Rim diameters. If you try to seat a Tire Bead on a mismatched Wheel and Tire by inflating it, the Tire Bead may break with explosive force, which could result in serious injury or death.

More information is available in OSHA standard 29 CFR 1910.177 (Servicing Multi-Piece and Single Piece Rim Wheels). All Operators should study this document prior to servicing any Tires.

## Mount a Tire

Mounting a Tire is the process of putting a Tire onto a Wheel.

**⚠ WARNING** Mounting a new Tire can be hazardous if not done correctly. Do not change a Tire unless you have been trained to do so. Failure to understand and follow proper procedures can result in injury or death.

During mounting, the Tire Bead goes over the Mount Lip of the Mount/Demount Head, but stays under the Demount Lip. See **Mount/Demount Head** for additional information.

Review the following points before mounting a Tire:

- Check the Tire and Wheel to make sure they are an **exact** match.
- If desired, replace the Wheel's Valve Stem before mounting the Tire.
- Make sure the Wheel is both clean and free of balancing weights. Remove any weights and any corrosion you find on the Wheel; **do not** service heavily corroded Wheels.
- Check the Tire for damage; **do not mount a damaged Tire**.
- Check the location of the TPMS and adjust the Tire if necessary. Do not damage the sensor.
- Check for yellow and red dots. If found, line them up with the appropriate locations on the Tire.
- Make sure the Tire is **fully** deflated.

When mounting a Tire, you mount the bottom Bead first (over the top Rim), then the top Bead.

### To mount a Tire:

1. Make sure you are wearing OSHA-approved (publication 3151) Personal Protective Equipment: leather gloves, steel-toed work boots, back belts, hearing protection, and ANSI-approved eye protection (safety glasses, face shield, or goggles).
2. If the Wheel is not already secured on the Turntable with the Narrow Side facing up, move the Wheel onto the Turntable and secure internally or externally.
3. Apply Tire lubricant to the top and bottom Beads and the top Rim.

4. Put the Tire over the Wheel, with the side that will be next to the Mount/Demount Head low and the other side high (above the top of the Wheel).
5. Swing the Mount/Demount Head into position.
6. Bring up the low side of the Tire and put the **bottom** Tire Bead over the Mount Lip and under the Demount Lip of the Mount/Demount Head.

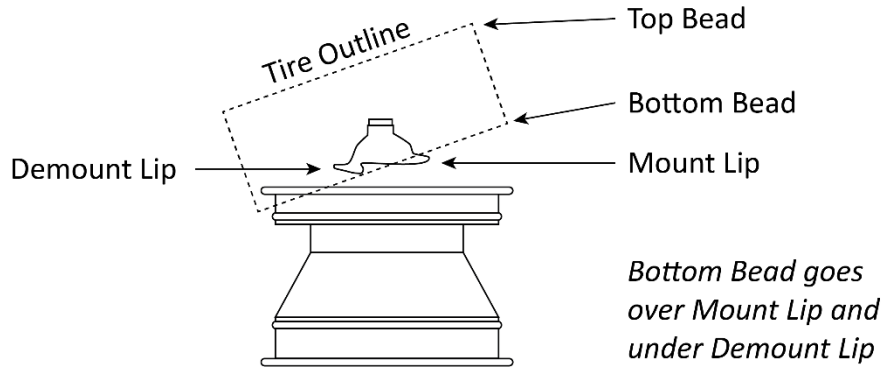

*Side view. Not to scale.*

7. Push the side of the Tire furthest away from the Mount/Demount Head down over that side of the Rim and Wheel as far as it will go.
8. On the opposite side of the Tire, make sure the bottom Tire Bead is in the Wheel's Drop Center.
9. Press down on the Turntable Foot Pedal.

The Turntable will turn clockwise and the bottom Tire Bead will drop over the top of the Rim.

10. Put the **top** Tire Bead over the Mount Lip and under the Demount Lip of the Mount/Demount Head.

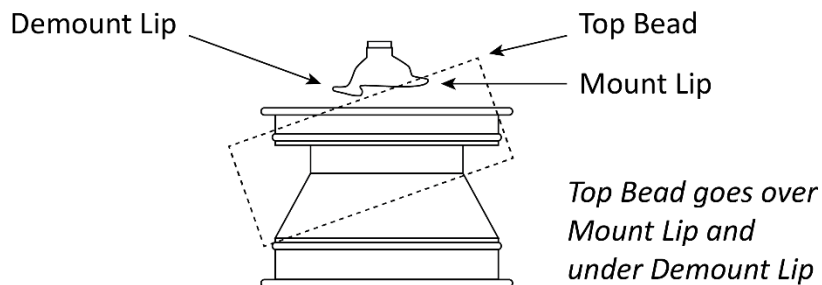

*Side view. Not to scale.*

11. Position the Bead Lifting Tool to the left of the Mount/Demount Head (about 20 percent of the distance around the Tire), with the Bead Lifting Tool pushing down on the Sidewall of the Tire.

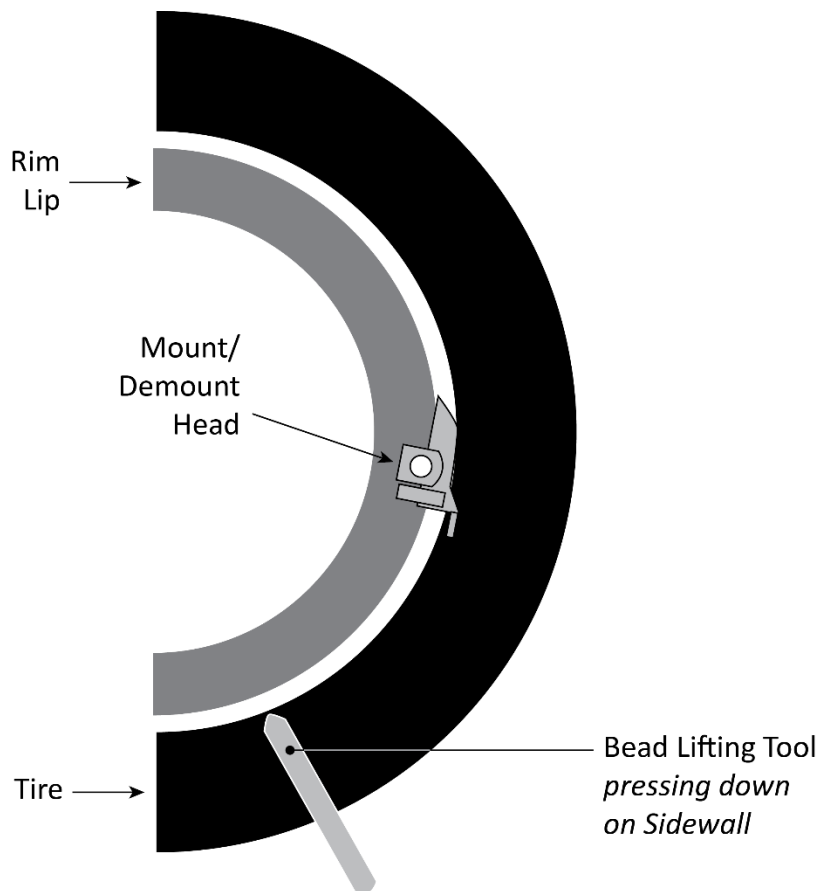

*Top view. Not to scale.*

12. When you start rotating the Tire, move the Bead Lifting Tool around as the Tire moves around, keeping the Tool at the same spot on the Tire.
13. Press down on the Turntable Foot Pedal to move the Turntable clockwise.  
If using the Bead Lifting Tool to hold down the Sidewall starting near the Mount/Demount Head, move it around with the Tire as it rotates.
14. If you run into any difficulty as the Tire rotates, take your foot off the Turntable Foot Pedal to stop the Turntable, then press up on the Turntable Foot Pedal to turn the Turntable counterclockwise. Make any necessary adjustments and then proceed.

Eventually the top Tire Bead slips under the Rim. How long this takes can vary, based on the Tire you are mounting.

The Tire is now in place around the Wheel Rim. The next step is to inflate the Tire.

---

## Inflate the Tire

Tire inflation has three stages:

- **Bead sealing** is putting in a small amount of air pressure to push the Tire up against the Rim so the rest of the air you put in does not leak out. *Remove the Valve Core before beginning the Bead sealing*, as that allows more air to go in through the Valve Stem.
- **Bead seating** is putting more air pressure into the Tire until you hear a “pop”, which indicates the Beads (on both sides of the Tire) have slipped over the Bead Humps into their Bead Seats. *Put the Valve Core back in once the Beads are seated*.
- **Inflation** is adding more air pressure to the Tire to get the pressure up to the manufacturer’s recommended pressure for the Tire. **Do not stand over the Tire when inflating it.**

Each of these stages is covered separately below.

 **CAUTION** The inflation process can produce noise. Wear ear protection when inflating a Tire.

 **WARNING** Do not exceed the maximum air pressure specified by the Tire manufacturer. This increases the chances that the Tire could explode, causing injury or death.

Use the Pressure Gauge on the Inflation Gun to monitor the air pressure in the Tire you are inflating.

 **DANGER** If you are inflating a Tire that requires more than 60 psi, you **must** use a **Tire Inflation Cage such as the RIC-4716** for safety purposes. If a Tire fails at high pressure, it can explode and cause serious injury or death to anyone near it. Using a Tire Inflation Cage helps reduce the danger.

Important inflation notes:

- Identify the **recommended** inflation pressure of the Tire (can usually be found on a sticker on the driver-side doorjamb of the vehicle or in the owner’s manual) and the **maximum** inflation pressure of the Tire (usually located on the sidewall; “Max. Press. 35 psi” or something similar). When inflating, **your goal is the recommended inflation pressure**; do not exceed the maximum inflation pressure when inflating the Tire.
- Make sure the Tire is restrained for inflation: either *internally* clamped or in a Tire Inflation Cage. Do not inflate a Tire if it is **externally** clamped; external clamping interferes with inflation.

### **Bead Sealing**

To seal a Tire’s Beads, you put a small amount of air pressure into the Tire, which pushes the Tire up against the Rim so that additional air you put in does not leak out.

#### **To Seal the Beads:**

1. Make sure you are wearing OSHA-approved (publication 3151) Personal Protective Equipment: leather gloves, steel-toed work boots, back belts, hearing protection, and ANSI-approved eye protection (safety glasses, face shield, or goggles).
2. Make sure the Valve Core has been removed.
3. Pick up the Inflation Gun, then clip the Air Chuck to the Valve Stem.

The Air Chuck includes a self-gripping clip so you do **not** have to hold it in place during inflation.

 **WARNING** **Do not hold the Air Chuck while you are inflating a Tire.** This leaves you close to the Tire, which could result in injury if there is a problem during inflation.

- 
4. Press and hold down the Trigger on the Inflation Gun for a second or two.

Air goes into the Tire and seals the Bead.

Bead Sealing takes very little air pressure, anywhere from 0 to 3 psi, which you can monitor on the Pressure Gauge.

You know the Bead is sealed when you no longer hear the sound of air coming out from between the Wheel Rim and the Tire Beads.

5. Check to make sure the upper and lower Beads are sealed against the Rim.

If the Beads are **not** sealed, try again, this time putting it slightly more air.

### ***Bead Seating***

To seat a Tire's Beads, you put in additional air pressure until you hear a "pop", which indicates the Tire Beads have slipped over the Bead Humps into their Bead Seats.

Remember that a Tire has Beads on *both sides* of the Tire. The Beads have to be seated on both sides. Bead Seating is not complete until the Beads are seated on both sides of the Tire.

 **WARNING**    ***Do not exceed 40 psi to seat a Bead.***

The following procedure assumes the Tire's Beads have already been sealed. Do not try to seat the Beads until the Beads have been successfully sealed.

#### **To Seat the Beads:**

1. Make sure the Air Chuck is clipped to the Valve Stem of the Tire.
2. Step back from the Tire.
3. Press and hold down the Trigger on the Inflation Gun.

Air begins flowing into the Tire.

After a few seconds, you should hear a "pop" as the Beads are seated.

Bead Seating usually requires 7 psi or above.

***Some Beads are hard to seat, but never exceed 40 psi to seat the Bead.***

If air pressure in the Tire gets to 40 psi but the Beads are still **not** seated, use the Pressure Relief Button to remove air down to about 5 psi and then try again to seat the Beads. If you lower the psi too far, you may lose the Bead seal and have to do that again.

4. Release the Trigger.
5. If the Beads do not seat on a second attempt, either:
  - get a different Tire
  - ask your supervisor for instructions
  - let all of the air out of the Tire and start again (seal the Beads and then attempt to seat the Beads again)
6. If the amount of air pressure it takes to seat the Beads exceeds the manufacturer's recommended psi for the Tire, use the Pressure Relief Button to remove air pressure from the Tire, bringing it back down to the recommended psi for the Tire.
7. When the Beads are seated, remove the Air Chuck from the Valve Stem and **reinstall the Valve Core.**

---

## ***Inflating the Tire***

To inflate a Tire after sealing and then seating the Beads, add air pressure to the Tire to get the pressure to the manufacturer's recommended pressure.

Use the Pressure Gauge to monitor air pressure; do not 'guesstimate' the psi.

**⚠ DANGER** If you are inflating a Tire that requires more than 60 psi, you **must** use a **Tire Inflation Cage such as the RIC-4716** for safety purposes. If a Tire fails at high pressure, it can explode and cause serious injury or death to anyone near it. Using a Tire Inflation Cage helps reduce the danger.

The typical inflation pressure for automobile Tires is from approximately 25 to 45 psi. Light truck Tire inflation pressures typically cover a wider range.

**Do not exceed** the Tire manufacturer's **maximum** air pressure for a Tire. Your goal is to get to the Tire's **recommended** pressure.

The Tire Changer has an air pressure limiter that is set at the factory so that it does **not** exceed 60 psi. **Do not override the pressure limiter.**

Do not inflate a Tire if it is *externally* clamped; external clamping interferes with inflation. Instead, switch to internal clamping or restrain the Tire in an Inflation Cage.

**⚠ DANGER** Inflating a Tire with a bypassed pressure limiter could result in the Tire exploding, which could injure or kill bystanders or the Tire Changer Operator. Do not exceed 60 psi unless the Tire is in a Tire Inflation Cage.

### **To inflate a Tire:**

1. Verify that both the upper and lower Beads are sealed and seated.
2. Verify that the Valve Core has been put back in.
3. Make sure the Air Chuck is clipped to the Valve Stem of the Tire using the self-gripping clip.
4. Step back from the Tire.

**⚠ DANGER** Do **not** stand over the Tire when inflating it. If the Tire explodes during inflation (which does not happen often, but does happen), you could be injured or killed if you are standing over the Tire when it explodes.

5. Press and hold the Trigger on the Inflation Gun.  
Air begins flowing into the Tire.
6. Inflate the Tire to the manufacturer's **recommended** psi by monitoring the Pressure Gauge.
7. Release the Trigger.
8. Remove the Air Chuck from the Valve Stem.
9. Take the Wheel off the Tire Changer.

---

# Maintenance

Make sure your Tire Changer is maintained on a regular basis.

 **WARNING** Disconnect the Tire Changer from power and the incoming air from the Air Source **before performing any Maintenance**. Take whatever steps are necessary to make sure the unit cannot be re-energized until Maintenance is over (such as Lockout/Tagout). Because the unit uses electrical and pneumatic energy, you could be electrocuted or even killed if the unit is powered back on during Maintenance.

The Tire Changer uses pneumatic and electrical energy; if your organization has **Lockout/Tagout policies**, make sure to implement them before performing maintenance on the Tire Changer.

## Regular Maintenance

- **Daily:** Make sure the unit is clean and dry.
- **Weekly:** Check all labels to make sure they are in place and legible. Contact BendPak Ranger if replacement labels are needed.
- **Weekly:** Check the water level of the Regulator/Filter. If the reservoir is one quarter (25%) or more filled with water, drain it. Refer to **Check the Water Level** for instructions.
- **Weekly:** Check the oil feed rate of the Oiler/Lubricator. It should be 1 to 2 drops per use of a pneumatic component. If it is above or below this level, you need to adjust it. Refer to **Check the Oil Feed Rate and Adding Oil** for instructions.
- **Weekly:** Check the amount of pneumatic oil in the Oiler/Lubricator reservoir. If it is under one half (50%) full, add oil. Refer to **Check the Oil Feed Rate and Adding Oil** for instructions.
- **Monthly:** Check the accuracy of the Pressure Gauge using a pressurized tire and a high-quality pressure gauge. Fix immediately if not working correctly.
- **Monthly:** Make sure all Anchor Bolts are tightened and secure, if used.
- **Monthly:** Make sure all components are in good operating condition. If you find a component that is **not** working correctly, take the Tire Changer out of service and refer to **Troubleshooting** for more information.
- **Yearly:** Take the Tire Changer out of service, disconnect the Power Cord from the power source, and then thoroughly check and clean all components.

 **WARNING:** Do not operate your Tire Changer if you find issues; instead, take the unit out of service, then contact your dealer, visit [rangerproducts.com/support/](http://rangerproducts.com/support/), or call **(805) 933-9970**.



---

## Check the Water Level

Water coming in from the Air Source is pulled out of the incoming air by the Regulator/Filter and dropped into the reservoir at the bottom.

This water needs to be drained periodically.

### To drain water from the Regulator/Filter reservoir:

1. Check the Water Sight Gauge to see how much water is currently in the reservoir.  
If the reservoir is one quarter (25%) or more filled with water, you need to drain it.
2. Disconnect the Air Source at the Air In connector.

**⚠ WARNING** Make sure to disconnect the Air Source and make sure it cannot be reconnected until you are done draining the water from the Regulator/Filter. If the Air Source is reconnected during the procedure, it could damage the Regulator/Filter, the Tire Changer, and possibly injure bystanders.

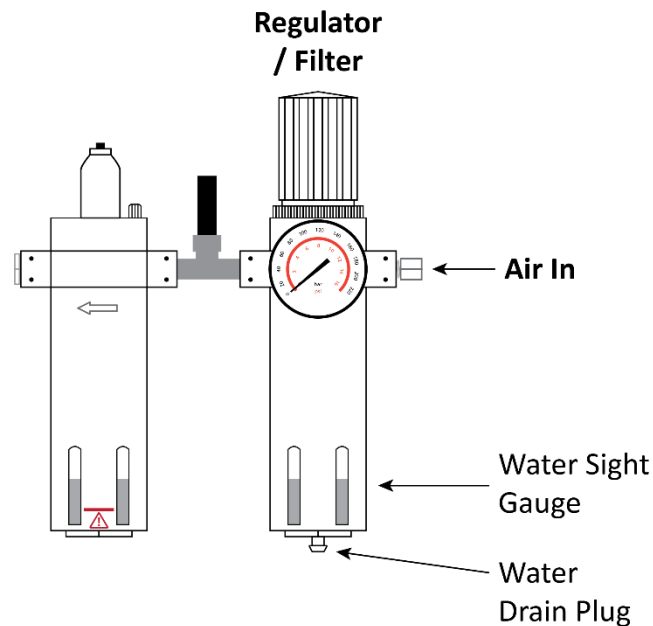

3. Press upwards on the Water Drain Plug at the bottom of the reservoir.  
The water drains out.
4. Release the Water Drain Plug.
5. Re-connect the Air Source.

---

## Check the Oil Feed Rate and Adding Oil

The built-in lubricator adds pneumatic oil to the incoming air. This ensures that all pneumatic components of the Tire Changer receive the necessary lubrication, which maintains operating performance, reduces wear, and extends service life.

It is very important to make sure the oil feed rate is correct, 1 or 2 drops of oil per use of a pneumatic component (such as the Clamps In or Out Foot Pedal), and that there is enough pneumatic oil in the Oil Reservoir of the Oiler/Lubricator.

### To check the oil feed rate on the Oiler/Lubricator:

1. With the Air Source connected, press and release the Clamps In Foot Pedal.  
You do not need a Tire, you just need to use a pneumatic tool.
2. Watch the Sight Glass to see how much pneumatic oil comes out each time you press and release the Clamps In or Out Foot Pedal.  
Your goal is for 1 or 2 drops to come out each time.
3. If you are getting **fewer** than 1 or 2 drops, turn the Adjustment Screw counter-clockwise (using a small flat-head screwdriver), then press the Clamps In or Out Foot Pedal again to check the output.
4. If you are getting **more** than 1 or 2 drops, turn the Adjustment Screw clockwise, then press the Clamps In or Out Foot Pedal again to check the output.
5. When you are getting 1 or 2 drops, stop.

### To add pneumatic oil to the Oiler/Lubricator:

1. Check the Oil Sight Gauge to see how much pneumatic oil is currently in the reservoir.  
If the reservoir is less than one half (50%) filled with pneumatic oil, you need to add oil to it.
2. Disconnect the Air Source at the Air In connector.
3. Turn the Oil Fill Cap on the top of the Oil Reservoir counter-clockwise and pull it off.
4. Add SAE 10W Air Tool Oil or generic pneumatic oil to the reservoir.
5. Put the Oil Fill Cap back in place, turning it clockwise until tight.
6. Re-connect the Air Source.

---

# Troubleshooting

 **WARNING:** Disconnect the Power Cord from power and the incoming air from the Air Source **before performing any maintenance.** Take whatever steps are necessary to make sure the unit **cannot** be re-energized while maintenance is being performed on it. The unit uses pneumatic and electrical energy; if your organization has Lockout/Tagout policies, make sure to implement them before troubleshooting the Tire Changer.

<b>Issue</b>	<b>Action to Take</b>
The Turntable does not move when you step on the Turntable Foot Pedal.	Make sure the unit is getting power.
The Tire Changer is not getting power.	Have a licensed, certified Electrician check the electrical path from the supplied cord to the power source. If any issues are found, have them fixed.
No air comes out when you press the Trigger on the Inflation Gun.	Make sure the Tire Changer is correctly connected to a working air source.
It is difficult to secure Tires when clamping externally.	Press the Tire down so the Clamps correctly grab the Rim of the Wheel.
The Pressure Gauge is not working correctly.	Check the accuracy of the Gauge with a professional gauge. Fix immediately if the Gauge is not working correctly.

If you continue to have problems with your Tire Changer, visit [www.bendpak.com/support/](http://www.bendpak.com/support/) or call **BendPak Ranger at (805) 933-9970.**

# Labels

**A**



**B**



**C**



**D**



**E**



**F**



**G**



**H**



**I**



**J**



**K**



L

# CAUTION

This equipment has been set and wired for 110 volt operation. For 220 volt operation, the selector switch must first be switched to 220.

M

**ATTENTION OWNER: Assorted factory replacement spare parts are located inside under plastic cover. → DO NOT REMOVE unless replacement is necessary.**

N

## IMPORTANT - PLEASE READ

### FILTER / REGULATOR LUBRICATOR INSTRUCTIONS

#### WARNING!

Failure to regularly drain water and maintain proper oil level and oil feed rate will damage internal pneumatic components and void product warranty.

The inline lubricator helps ensure that all pneumatic components inside this machine receive the required lubrication to maintain operating performance, reduce wear and prolong service life. It is designed to automatically provide the correct amount of oil feed rate required within the pneumatic system delivering a constant ratio of oil to CFM.

The filter/regulator is designed to remove airborne solid and liquid contaminants which may plug small orifices and hinder performance or cause excessive wear and premature equipment failure. The regulator provides controlled and consistent air pressure as required. NOTE: This model requires 15-25 CFM air source with a safe operating air pressure of 140-165 PSI for optimum machine performance.

#### Water Separator / Lubricator Maintenance

- Check oil and water levels regularly and perform these maintenance items weekly.
- Observe the water sight gauge on the water separator/filter unit. If water is observed, drain by pressing upwards on the drain plug at the bottom of the reservoir.
- Observe the sight glass and adjust the oil feed rate by turning the small adjustment screw on the top of the glass bowl so that 2-3 drops of oil drip through the site glass for each operation of the bead loosener pedal.

#### Adding Oil to Oiler / Lubricator

If oil level is low, add oil as follows:

1. IMPORTANT - First disconnect air source from machine.
2. Remove oil reservoir by unthreading reservoir from head of oiler/lubricator.
3. Add oil as necessary.

4. Replace reservoir making sure rubber O-ring is seated properly and reservoir is firmly tightened hand-tight.

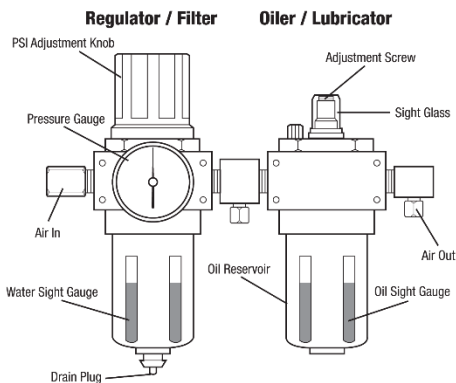

PN 5900285

