

# ADAS

ADVANCED DRIVER ASSISTANCE SYSTEM

## INTRODUCING THE INTELLIGENT ADAS IA900WA SYSTEM

FIRST TO PERFORM BOTH  
WHEEL ALIGNMENT  
& ADAS CALIBRATION

LOOK INSIDE FOR THE  
ADAS PACKAGE  
THAT MEETS YOUR NEEDS



### ADAS CALIBRATION SYSTEM PACKAGES



IA900WA



IA800



STANDARD



MA600

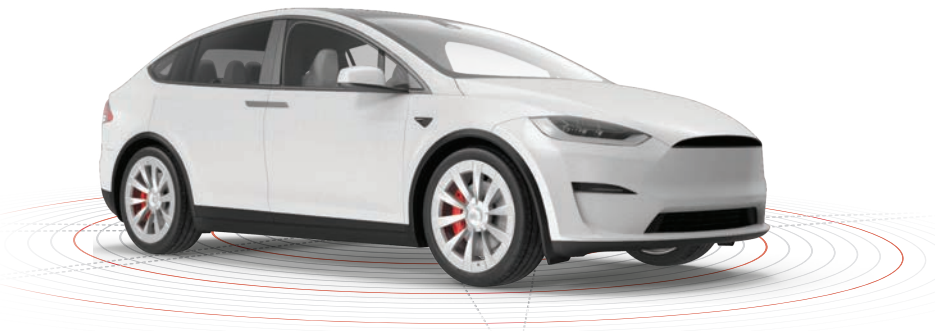

# ADAS & YOU

## ADDING THE ADAS ADVANTAGE TO YOUR SHOP

**W**hat is ADAS? Almost all vehicle accidents are caused by human error, which can be avoided with Advanced Driver Assistance Systems (ADAS). The role of ADAS is to prevent deaths and injuries by reducing the number of car accidents and the serious impact of those that cannot be avoided.

Essential ADAS Applications Include:

- PEDESTRIAN DETECTION/AVOIDANCE
- LANE DEPARTURE WARNING/CORRECTION
- AUTOMATIC EMERGENCY BRAKING
- BLIND SPOT DETECTION

These lifesaving systems are key to ensuring the success of ADAS applications, incorporating the latest interface standards and running multiple vision-based algorithms to support real-time multimedia, vision co-processing, and sensor fusion subsystems.



### SMART GROWTH WHY YOU NEED TO OFFER ADAS SERVICES

#### INDUSTRY FORECAST

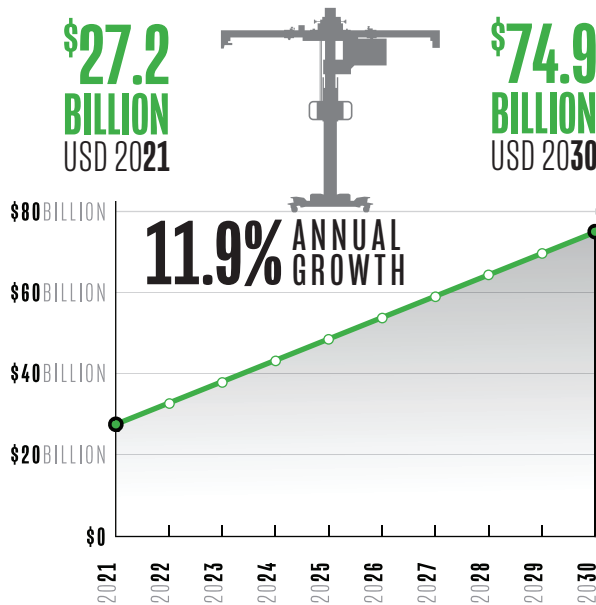

The growth of the ADAS Market can be attributed to the increasing adoption of ADAS systems by OEMs for product differentiation and the ever increasing issue of road safety.

As repairing ADAS-equipped vehicles becomes more of a necessity, turn to Autel, the industry leader for state-of-the-art Calibration Frames, Diagnostic Tablets, Software, and ADAS Targets.

The ADAS Market is expected to reach USD 74.9 Billion by 2030, growing at a Compound Annual Growth Rate (CAGR) of 11.9% during the forecast period.

Source: [marketsandmarkets.com](https://www.marketsandmarkets.com)

SCAN FOR MORE INFORMATION



# ADAS APPLICATIONS WHAT THEY ARE & WHAT THEY DO



**ACC | ADAPTIVE CRUISE CONTROL**  
Adjusts Vehicle Speed to Maintain a Safe Distance with Vehicles Ahead



**AVM | AROUND VIEW MONITORING**  
Provides 360-Degree, Bird's-Eye View to Help with Drivers Park More Easily



**BSD | BLIND SPOT DETECTION**  
Detects and Warns Driver of Vehicles in Either Driver or Passenger Rear Corners (Blind Spot)



**LDW | LANE DEPARTURE WARNING**  
Warns Driver when the Vehicle Drifts Out of Their Lane



**LIDAR | LIGHT IMAGING DETECTION & RANGING**  
Detects Objects in Vehicle Vicinity to Create a 3D Map of Objects and Surroundings



**NVS | NIGHT VISION SYSTEM**  
Improves a Driver's Vision in Darkness or Poor Weather



**RCW | REAR COLLISION WARNING**  
Warns the Driver of Vehicles Coming Close to the Rear of Their Vehicle

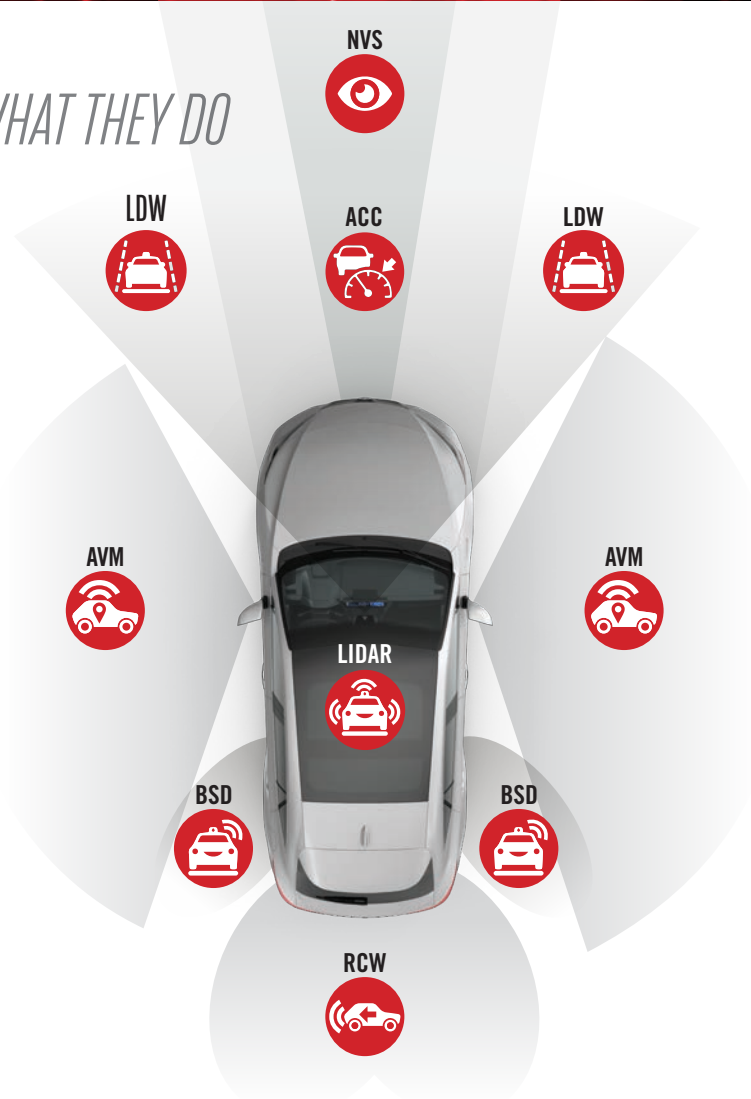

## CALIBRATION WHEN IS IT REQUIRED?

- WINDSHIELD REPLACEMENT
- SUSPENSION REPAIRS
- WHEEL ALIGNMENT
- SENSOR/MOUNTING BRACKET REPLACEMENT
- TIRE SIZE CHANGE
- RELATED DTC IS PRESENT
- FRONT AIRBAG DEPLOYMENT IF DEFLECTED OFF WINDSHIELD
- ADAS-RELATED TSBS/MANUFACTURER POSITION STATEMENT REQUIREMENTS\*
- MECHANICAL PROCEDURES LIKE RADIATOR AND CONDENSER REPAIRS THAT REQUIRE REMOVAL OF FRONT-MOUNTED SENSORS

*\*Refer to NHTSA, the manufacturer or ADAS Tech Support for more information*

## SERVICE PROFITS

- HAVING YOUR OWN ADAS CALIBRATION SYSTEM SAVES YOU TIME AND MONEY THAT WOULD BE SPENT WORKING WITH ANOTHER SHOP
- IMPROVES CYCLE TIME, ALLOWS YOUR SHOP FULL CONTROL OF THE REPAIR
- NO LONGER TRANSPORTING VEHICLES BETWEEN SHOPS INCREASES UP TIME
- AUTEL ADAS USERS REPORT **EARNING 50% ROI (FULL COST OF INVESTMENT) AS EARLY AS 4-6 WEEKS WITH REGULAR USE**

# ADAS CALIBRATION SYSTEMS

FIND A SYSTEM THAT MEETS YOUR SHOP'S REQUIREMENTS



## IA900WA

Offers Both Wheel Alignment & ADAS Calibration Capability In A Single, Affordable System. Improve Shop Efficiency & Profitability.

IDEAL FOR:



### ACCESSORIES INCLUDED

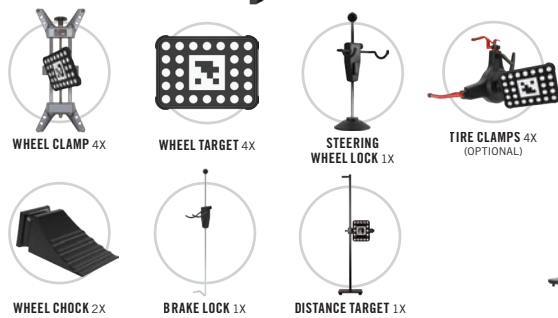

### AVAILABLE PACKAGES

- IA900WA PART# IA900WA (PG. 8)
- IA900WA +TABLET PART# IA900WAT (PG. 8)
- IA900WA LDW PART# IA900LDW (PG. 8)
- IA900WA LDW +TABLET PART# IA900LDWT (PG. 8)
- IA900WA ALL SYSTEMS PART# IA900AS (PG. 9)
- IA900WA ALL SYSTEMS +TABLET PART# IA900AST (PG. 9)

### AVAILABLE PACKAGES

- STANDARD LDW PART# LDW20 (PG. 16)
- STANDARD LDW +TABLET PART# LDW20T (PG. 16)
- STANDARD ALL SYSTEMS PART# AS20 (PG. 17)
- STANDARD ALL SYSTEMS +TABLET PART# AS20T (PG. 17)

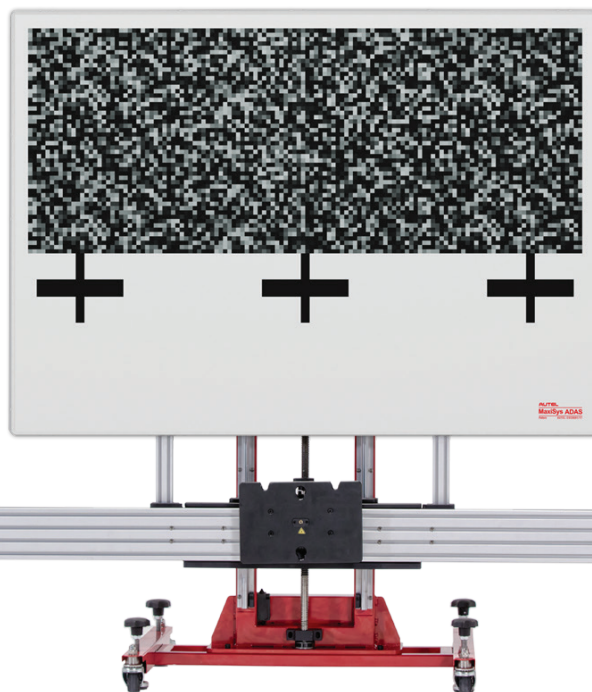

### ACCESSORIES INCLUDED



IDEAL FOR:



## STANDARD

Ideal for In-Shop Calibrations, for use on an alignment lift, or integrated with a compatible Alignment Machine. The sturdy, adjustable frame provides a new station to bring ADAS Calibration services in-house.



**IA800** Available as a complete package or as an easy to install upgrade of your Autel Standard Calibration System. Provides the fastest, most accurate target positioning without mechanical measurements. Also performs Wheel Alignment Pre-Check.

IDEAL FOR:



BODY SHOP



GLASS REPAIR



GENERAL REPAIR

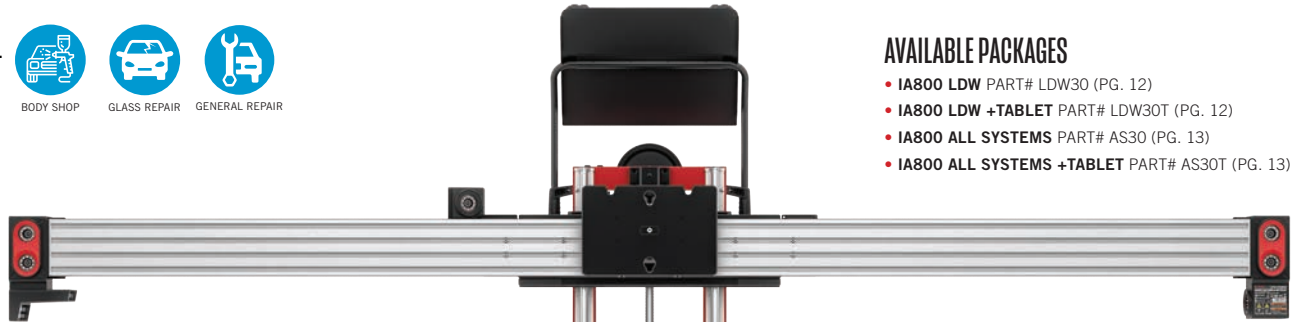

**AVAILABLE PACKAGES**

- IA800 LDW PART# LDW30 (PG. 12)
- IA800 LDW +TABLET PART# LDW30T (PG. 12)
- IA800 ALL SYSTEMS PART# AS30 (PG. 13)
- IA800 ALL SYSTEMS +TABLET PART# AS30T (PG. 13)

**ACCESSORIES INCLUDED**



WHEEL CLAMP 4X

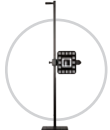

DISTANCE TARGET 1X



TIRE CLAMPS 4X (OPTIONAL)



WHEEL TARGET 4X



STEERING 1X

**ADAS ACCESSORIES PACKAGE**

PART NO: ADASACCESSORY (SOLD SEPARATELY)



TWO LINE LASER 1X

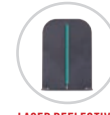

LASER REFLECTIVE BOARD 1X



FIVE LINE LASER 1X



L BRACKET 1X

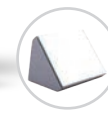

LASER ASSISTED REFLECTOR 1X



PLUMB LINE 1X



TRAVEL CASE 1X

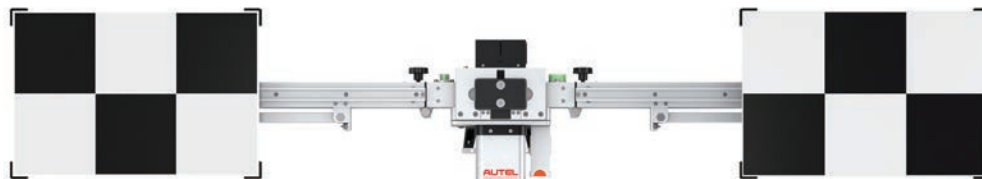

**AVAILABLE PACKAGES**

- MA600 LDW PART# MA60020 (PG. 20)
- MA600 LDW +TABLET PART# MA60020T (PG. 20)
- MA600 ALL SYSTEMS PART# MAS20 (PG. 21)
- MA600 ALL SYSTEMS +TABLET PART# MAS20T (PG. 21)

**ACCESSORIES INCLUDED**



TWO LINE LASER 1X



LASER ASSISTED REFLECTOR 1X

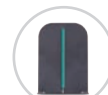

LASER REFLECTIVE BOARD 1X



MOUNTING PLATE 1X  
\*AVAILABLE WITH ALL SYSTEM PACKAGES ONLY.



L BRACKET 1X



FIVE LINE LASER 1X



PLUMB LINE 1X

IDEAL FOR:



COMPACT



MOBILE



GLASS REPAIR



BODY SHOP



**MA600** The Autel MaxiSYS ADAS MA600 portable calibration system is ideal for multi-location shops. The compact frame, folds and disassembles to easily fit into the trunk of a car or service truck for easy transportation.



# INTELLIGENT ADAS IA900WA SYSTEM

## FIRST SYSTEM TO OFFER BOTH WHEEL ALIGNMENT & ADAS CALIBRATION

Autel's Latest Development in ADAS Calibration Now Includes Wheel Alignment Technology.  
One System To Perform 4-Wheel Alignment & ADAS Calibration.

- PRECISE OPTICAL MEASUREMENT WITH 6 HIGH RESOLUTION CAMERAS
- CAMERAS AUTOMATICALLY TRACK VEHICLE HEIGHT ON LIFT
- AUTOMATIC TARGET HEIGHT SETTING
- TARGET PLACEMENT VERIFICATION
- CONTROL IA900 FROM MAXISYS ULTRA ADAS OR 24" TOUCHSCREEN
- MAXISYS TABLET HOLDER WITH BUILT-IN CHARGER
- UNEVEN FLOOR COMPENSATION



ADAS CALIBRATION



WHEEL ALIGNMENT



AUTO HEIGHT TRACKING



6 HI-RES CAMERAS



SELF-CALIBRATING



24" TOUCH SCREEN



# IMPROVE SHOP EFFICIENCY & PROFITABILITY

- IDEAL FOR:
- WHEEL ALIGNMENT
  - BODY SHOP
  - GLASS REPAIR
  - COMPACT

**DISCOVER A NEW  
WORKFLOW**



**IA900WA** PART NO: IA900WA

- IA900 WHEEL ALIGNMENT SYSTEM
- ACCESSORIES
- REQUIRES MAXISYS ULTRA, ADAS & WHEEL ALIGNMENT UPGRADE SOLD SEPARATELY

**IA900WA+TABLET** PART NO: IA900WAT

- IA900 WHEEL ALIGNMENT SYSTEM
- ACCESSORIES
- MAXISYS ULTRA ADAS TABLET & MAXIFLASH VCI
- ADAS & WHEEL ALIGNMENT SOFTWARE INCLUDED



**ACCESSORIES INCLUDED**

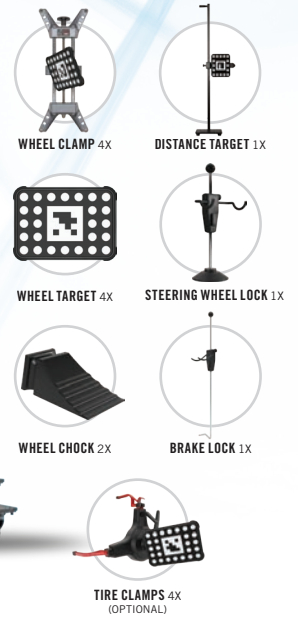

**IA900WA LDW PACKAGES**

EXPANDS LDW CALIBRATION CAPABILITIES

**IA900WA LDW** PART NO: IA900LDW

- IA900WA
- ACCESSORIES
- LDW TARGETS
- REQUIRES MAXISYS ULTRA, ADAS & WHEEL ALIGNMENT UPGRADE SOLD SEPARATELY

**IA900WA LDW+TABLET** PART NO: IA900LDWT

- IA900WA
- ACCESSORIES
- LDW TARGETS
- MAXISYS ULTRA ADAS TABLET & MAXIFLASH VCI
- ADAS & WHEEL ALIGNMENT SOFTWARE INCLUDED

**LANE DEPARTURE WARNING**

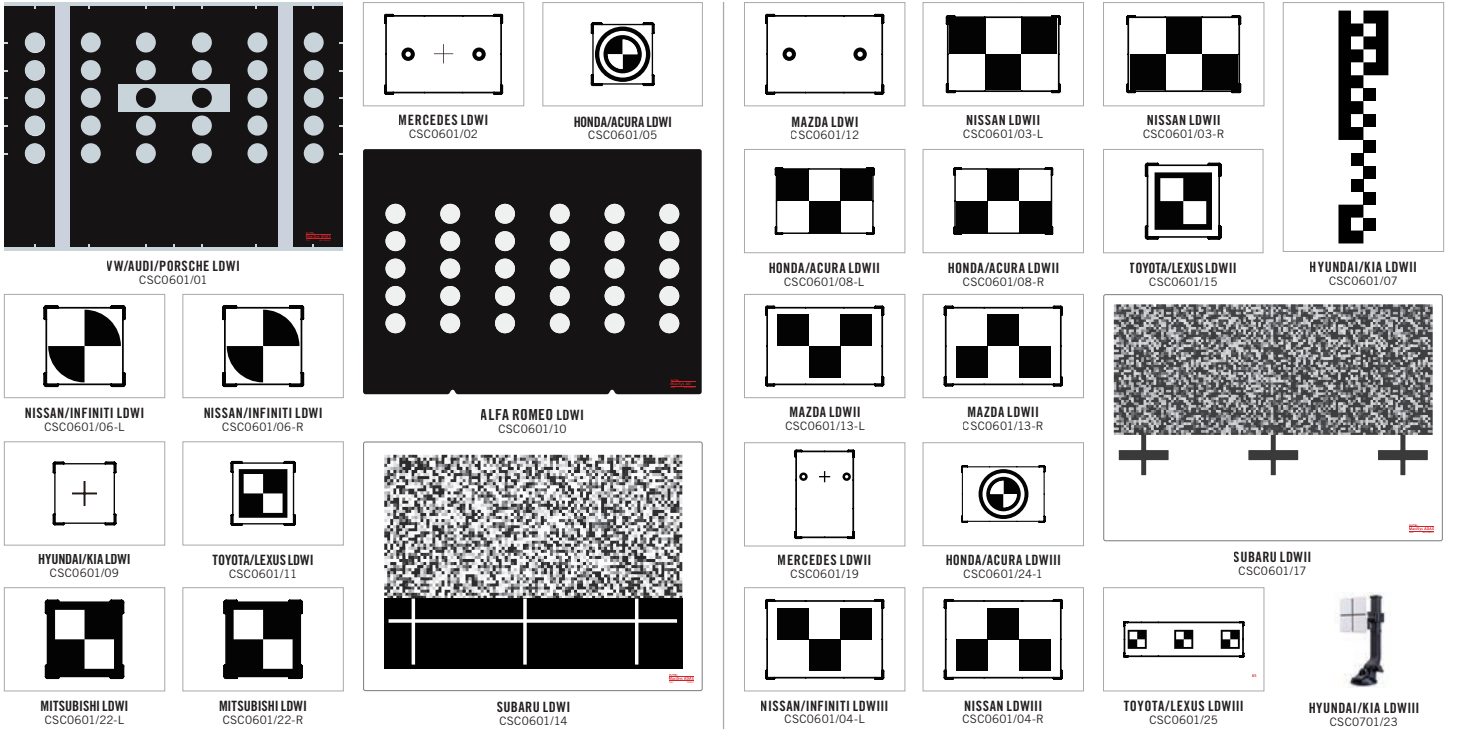





# IA900WA ALL SYSTEMS PACKAGES

THE ULTIMATE PACKAGES FOR CALIBRATION CAPABILITIES

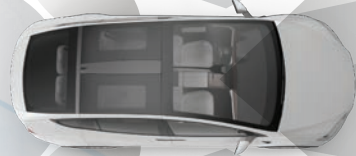



## IA900WA ALL SYSTEMS PART NO. IA900AS

- IA900WA
- ACCESSORIES
- LDW, AVM, NVS, ACC, BSD, LIDAR, RCW TARGETS
- REQUIRES MAXISYS ULTRA, ADAS AND WHEEL ALIGNMENT UPGRADE SOLD SEPARATELY

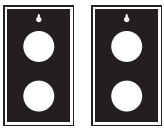

## IA900WA ALL SYSTEMS + TABLET PART NO. IA900AST

- IA900WA
- ACCESSORIES
- LDW, AVM, NVS, ACC, BSD, LIDAR, RCW TARGETS
- MAXISYS ULTRA ADAS TABLET & MAXIFLASH VCI
- ADAS & WHEEL ALIGNMENT SOFTWARE INCLUDED

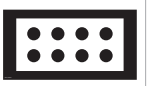
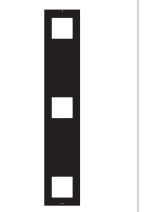
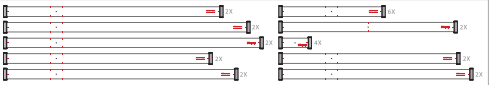
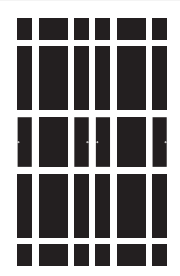
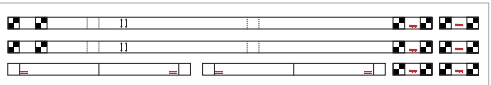

### AROUND VIEW MONITORING

					
<b>VW AVM</b> CSC0804/01	<b>HONDA AVM</b> CSC1004/02	<b>HONDA AVM</b> CSC1004/03	<b>CADILLAC AVM</b> CSC1004/06	<b>TOYOTA AVM</b> CSC1004/10	
					
				<b>HYUNDAI/ KIA AVM</b> CSC1004/04	

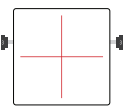

### NIGHT VISION SYSTEM

		
<b>VAG/GM NV CALIBRATOR</b> CSC0603/01	<b>LEXUS NV PATTERN</b> CSC0603/03	<b>MERCEDES NV STAND</b> CSC0803/01

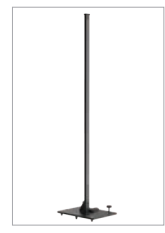

### ADAPTIVE CRUISE CONTROL

				
<b>ACC REFLECTOR</b> CSC0602/01	<b>RADAR CALIBRATION PLATE</b> CSC0602/02	<b>VW ADR CALIBRATION PLATE</b> CSC0602/08	<b>HITACHI RADAR PLATE</b> CSC0802/03	
				<b>MITSUBISHI AVM</b> CSC1004/09
				<b>NISSAN AVM</b> CSC1004/11

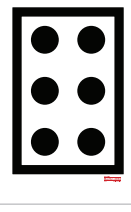

### BLIND SPOT DETECTION

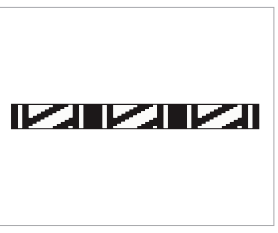
				
<b>RADAR CALIBRATION BOX</b> CSC0605/01	<b>CORNER REFLECTOR STAND</b> CSC0800	<b>CORNER REFLECTOR</b> CSC0802/01	<b>TARGET STAND</b> CSC0802	<b>HONDA LANEWATCH</b> CSC0805/02

### LIDAR

	
<b>VW/AUDI LIDAR CALIBRATION BOARD</b> CSC0602/04	<b>TOYOTA LIDAR REFLECTOR</b> CSC0802/04

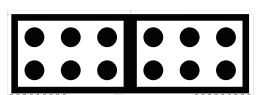
### REAR COLLISION WARNING

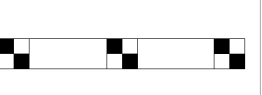
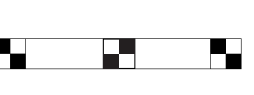
				
<b>VW RCWI</b> CSC0806/01	<b>MERCEDES RCWI</b> CSC1006/01	<b>MERCEDES RCWII</b> CSC1006/02	<b>NISSAN RCWI</b> CSC1006/03	<b>NISSAN RCWII</b> CSC1006/05



# INTELLIGENT ADAS IA800 SYSTEM

## FRAME PLACEMENT IN LITTLE AS 1 MINUTE

Available as a complete package or as an easy to install upgrade of your Autel Standard Calibration System. Provides the fastest, most accurate target positioning without mechanical measurements. Also performs Wheel Alignment Pre-Check.



ADAS CALIBRATION



6 HI-RES CAMERAS



WHEEL ALIGNMENT  
PRE-CHECK



IDEAL  
FOR:



BODY SHOP



GLASS REPAIR



GENERAL REPAIR

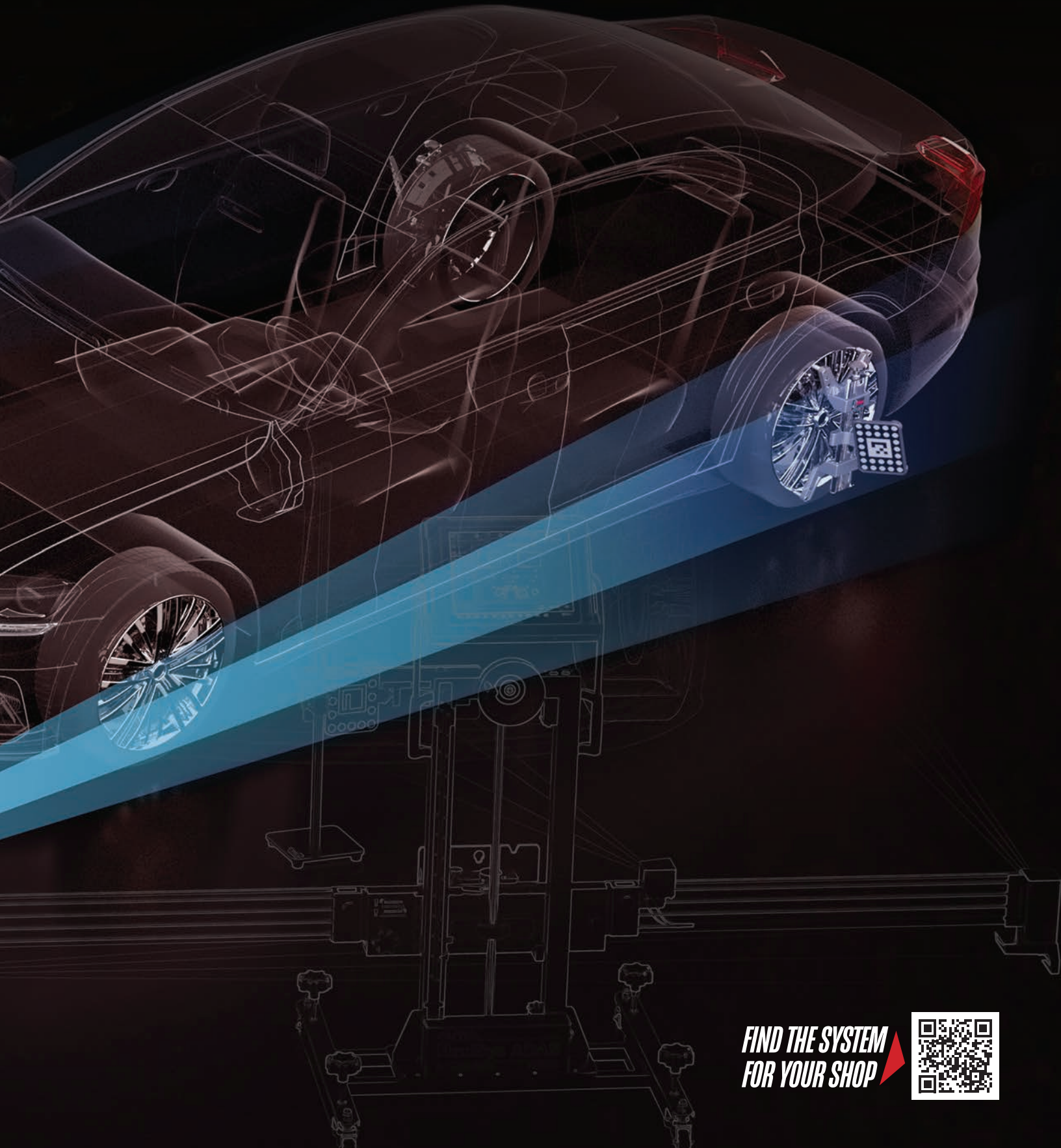

**FIND THE SYSTEM  
FOR YOUR SHOP**



MAXISYS  
I1800 CALIBRATION  
SYSTEM

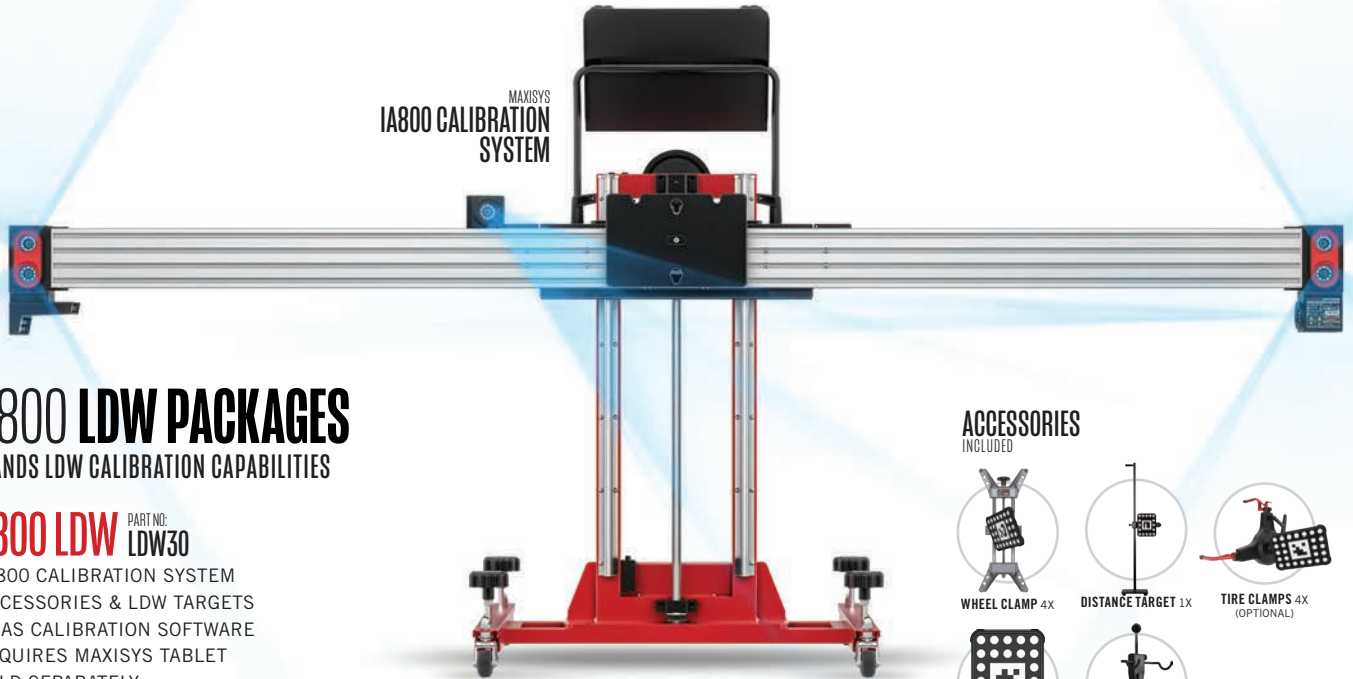

**I1800 LDW PACKAGES**  
EXPANDS LDW CALIBRATION CAPABILITIES

**I1800 LDW** PART NO: LDW30

- I1800 CALIBRATION SYSTEM
- ACCESSORIES & LDW TARGETS
- ADAS CALIBRATION SOFTWARE
- REQUIRES MAXISYS TABLET SOLD SEPARATELY

**I1800 LDW + TABLET** PART NO: LDW30T

- I1800 CALIBRATION SYSTEM
- LDW TARGETS
- ACCESSORIES
- MAXISYS MS909 TABLET
- MAXIFLASH VCI
- ADAS CALIBRATION SOFTWARE



ACCESSORIES  
INCLUDED

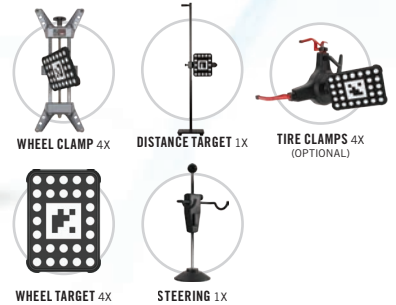

**LANE DEPARTURE WARNING**

VW/AUDI/PORSCHE LDW CSC0601/01	MERCEDES LDW CSC0601/02	HONDA/ACURA LDW CSC0601/05	MAZDA LDW CSC0601/12	NISSAN LDWII CSC0601/03-L	NISSAN LDWII CSC0601/03-R		HONDA/ACURA LDWII CSC0601/08-L	HONDA/ACURA LDWII CSC0601/08-R	TOYOTA/LEXUS LDWII CSC0601/15	HYUNDAI/KIA LDWII CSC0601/07
NISSAN/INFINITI LDW CSC0601/06-L	NISSAN/INFINITI LDW CSC0601/06-R	ALFA ROMEO LDW CSC0601/10	MAZDA LDWII CSC0601/13-L	MAZDA LDWII CSC0601/13-R			MERCEDES LDWII CSC0601/19	HONDA/ACURA LDWII CSC0601/24-1	SUBARU LDWII CSC0601/17	
HYUNDAI/KIA LDW CSC0601/09	TOYOTA/LEXUS LDW CSC0601/11	SUBARU LDW CSC0601/14	MERCEDES LDWII CSC0601/19	HONDA/ACURA LDWII CSC0601/24-1			NISSAN/INFINITI LDWIII CSC0601/04-L	NISSAN LDWIII CSC0601/04-R	TOYOTA/LEXUS LDWIII CSC0601/25	HYUNDAI/KIA LDWIII CSC0701/23
MITSUBISHI LDW CSC0601/22-L	MITSUBISHI LDW CSC0601/22-R	SUBARU LDW CSC0601/14	NISSAN/INFINITI LDWIII CSC0601/04-L	NISSAN LDWIII CSC0601/04-R	TOYOTA/LEXUS LDWIII CSC0601/25	HYUNDAI/KIA LDWIII CSC0701/23				



# IA800 ALL SYSTEMS PACKAGES

THE ULTIMATE PACKAGES FOR CALIBRATION CAPABILITIES

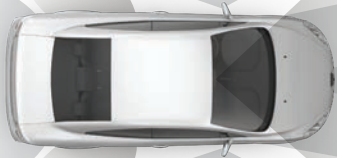

## IA800 ALL SYSTEMS PART NO: AS30

- IA800 CALIBRATION SYSTEM
- ACCESSORIES & LDW, AVM, NVS, ACC, BSD, LIDAR, RCW TARGETS
- ADAS CALIBRATION SOFTWARE
- REQUIRES MAXISYS TABLET & ADAS/ UPGRADE SOLD SEPARATELY

## IA800 ALL SYSTEMS + TABLET PART NO: AS30T

- IA800 CALIBRATION SYSTEM
- LDW, AVM, NVS, ACC, BSD, LIDAR, RCW TARGETS
- ACCESSORIES
- MAXISYS MS909 TABLET
- MAXIFLASH VCI
- ADAS CALIBRATION SOFTWARE

### AROUND VIEW MONITORING

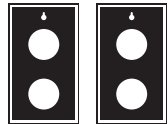

VW AVM  
CSC0804/01

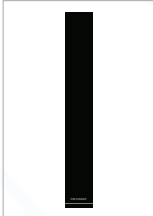

HONDA AVM  
CSC1004/02

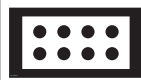

HONDA AVM  
CSC1004/03

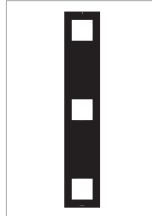

CADILLAC AVM  
CSC1004/06

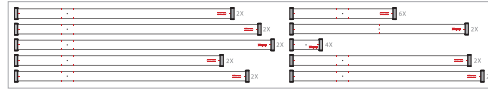

TOYOTA AVM  
CSC1004/10

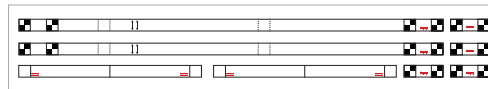

HYUNDAI/ KIA AVM  
CSC1004/04

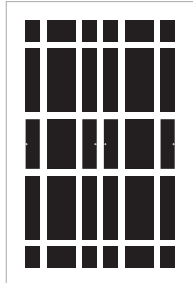

MITSUBISHI AVM  
CSC1004/09

### NIGHT VISION SYSTEM



VAG/GM NV CALIBRATOR  
CSC0603/01



LEXUS NV PATTERN  
CSC0603/03



MERCEDES NV STAND  
CSC0803/01

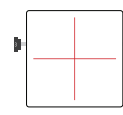

ACC REFLECTOR  
CSC0602/01



RADAR CALIBRATION PLATE  
CSC0602/02



VW ADR CALIBRATION PLATE  
CSC0602/08



HITACHI RADAR PLATE  
CSC0802/03

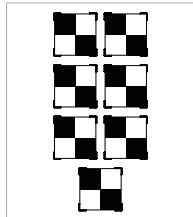

NISSAN AVM  
CSC1004/11

### ADAPTIVE CRUISE CONTROL

### BLIND SPOT DETECTION



CENTER AXIS LASER  
CSC0500/04



RADAR CALIBRATION BOX  
CSC0605/01



CORNER REFLECTOR STAND  
CSC0800

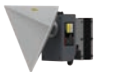

CORNER REFLECTOR  
CSC0802/01



TARGET STAND  
CSC0802

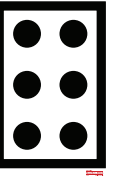

HONDA LANEWATCH  
CSC0805/02



VW/AUDI LIDAR CALIBRATION BOARD  
CSC0602/04



TOYOTA LIDAR REFLECTOR  
CSC0802/04

### LIDAR

### REAR COLLISION WARNING

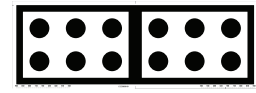

VW RCW  
CSC0806/01



MERCEDES RCW  
CSC1006/01



MERCEDES RCW  
CSC1006/02

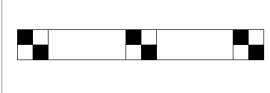

NISSAN RCW  
CSC1006/03

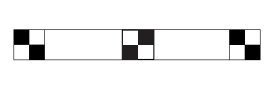

NISSAN RCW  
CSC1006/05



# ADAS STANDARD CALIBRATION PACKAGES

IDEAL FOR:

-  BODY SHOP
-  GLASS REPAIR
-  GENERAL REPAIR

## BRING ADAS CALIBRATION IN-HOUSE

The Autel MaxiSYS ADAS Standard calibration system is ideal for in-shop calibrations, for use on an alignment lift, or integrated with a compatible Alignment Machine. The sturdy, adjustable frame provides a new station to bring ADAS Calibration services in-house.



ADAS CALIBRATION

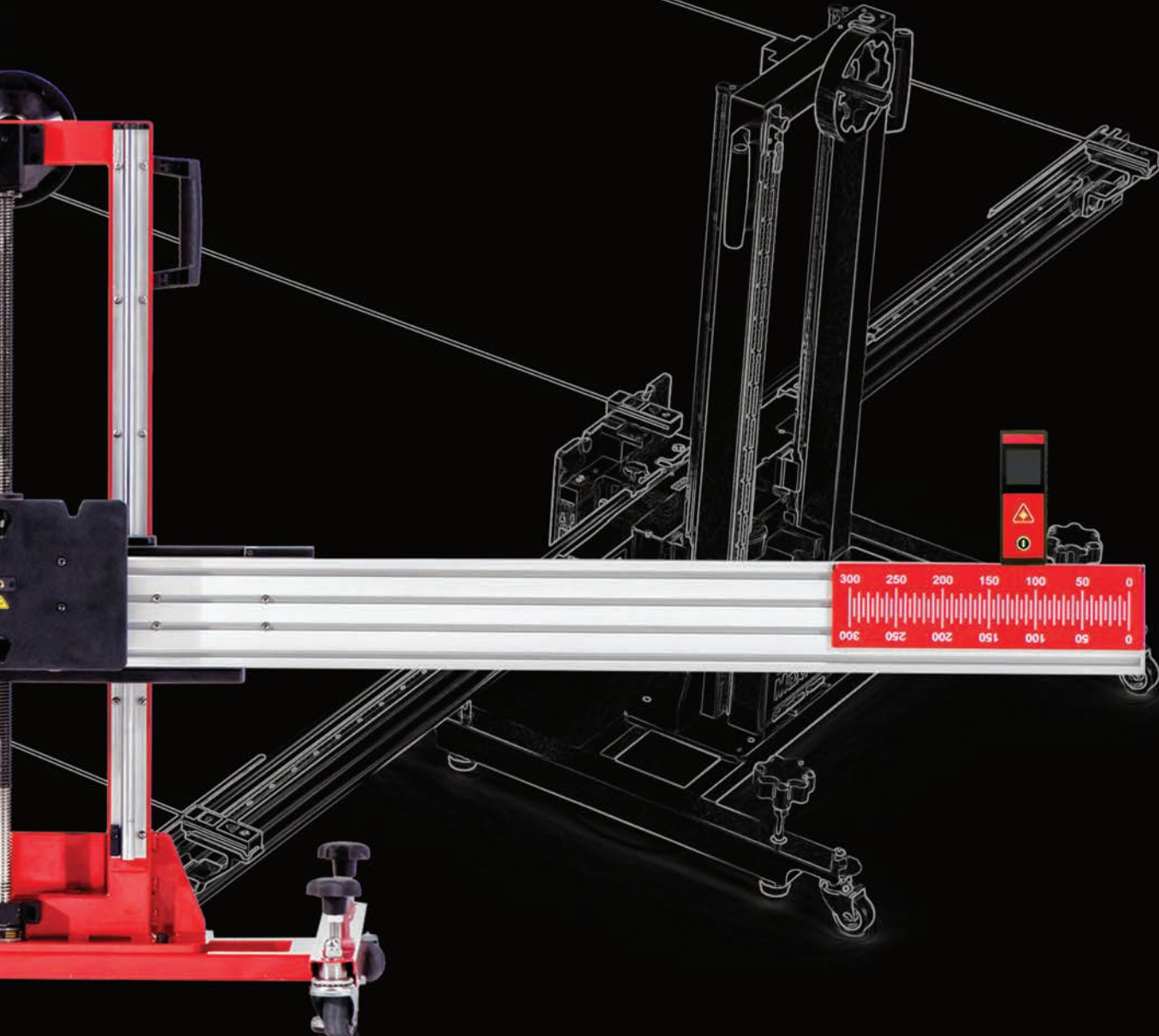

**FIND THE SYSTEM  
FOR YOUR SHOP**





MAXISYS  
ADAS STANDARD  
CALIBRATION  
SYSTEM



## STANDARD LDW PACKAGES

EXPANDS LDW CALIBRATION CAPABILITIES

### STANDARD LDW PART NO: LDW20

- STANDARD CALIBRATION SYSTEM
- ACCESSORIES & LDW TARGETS
- ADAS CALIBRATION SOFTWARE
- REQUIRES MAXISYS TABLET SOLD SEPARATELY

### STANDARD LDW + TABLET PART NO: LDW20T

- STANDARD CALIBRATION SYSTEM
- LDW TARGETS
- ACCESSORIES
- MAXISYS MS909 TABLET
- MAXIFLASH VCI
- ADAS CALIBRATION SOFTWARE



MAXISYS  
MS909  
TABLET

### ACCESSORIES INCLUDED

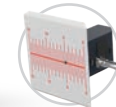

WHEEL CLAMP  
LASER 4X



FRONT WHEEL  
DIALS 2X



DIGITAL TAPE  
MEASURE 3X



WHEEL CLAMP  
LASER 4X



DIGITAL TAPE  
MEASURE CROSSBAR  
BRACKETS 2X



DIAL PLACEMENT  
BOARDS 2X



CENTER DIGITAL TAPE  
MEASURE BRACKET 1X

## LANE DEPARTURE WARNING

VW/AUDI/PORSCHE LDW CSC0601/01	MERCEDES LDW CSC0601/02	HONDA/ACURA LDW CSC0601/05	MAZDA LDW CSC0601/12	NISSAN LDWII CSC0601/03-L	NISSAN LDWII CSC0601/03-R	TOYOTA/LEXUS LDWII CSC0601/15	HYUNDAI/KIA LDWII CSC0601/07
NISSAN/INFINITI LDW CSC0601/06-L	NISSAN/INFINITI LDW CSC0601/06-R	ALFA ROMEO LDW CSC0601/10	HONDA/ACURA LDWII CSC0601/08-L	HONDA/ACURA LDWII CSC0601/08-R	TOYOTA/LEXUS LDWII CSC0601/15	SUBARU LDWII CSC0601/17	SUBARU LDWII CSC0601/17
HYUNDAI/KIA LDWII CSC0601/09	TOYOTA/LEXUS LDWII CSC0601/11	MAZDA LDWII CSC0601/13-L	MAZDA LDWII CSC0601/13-R	MERCEDES LDWII CSC0601/19	HONDA/ACURA LDWII CSC0601/24-1	SUBARU LDWII CSC0601/17	SUBARU LDWII CSC0601/17
MITSUBISHI LDWII CSC0601/22-L	MITSUBISHI LDWII CSC0601/22-R	SUBARU LDWII CSC0601/14	NISSAN/INFINITI LDWIIII CSC0601/04-L	NISSAN LDWIIII CSC0601/04-R	TOYOTA/LEXUS LDWIIII CSC0601/25	HYUNDAI/KIA LDWIIII CSC0701/23	HYUNDAI/KIA LDWIIII CSC0701/23





# STANDARD ALL SYSTEMS PACKAGES

THE ULTIMATE PACKAGES FOR CALIBRATION CAPABILITIES

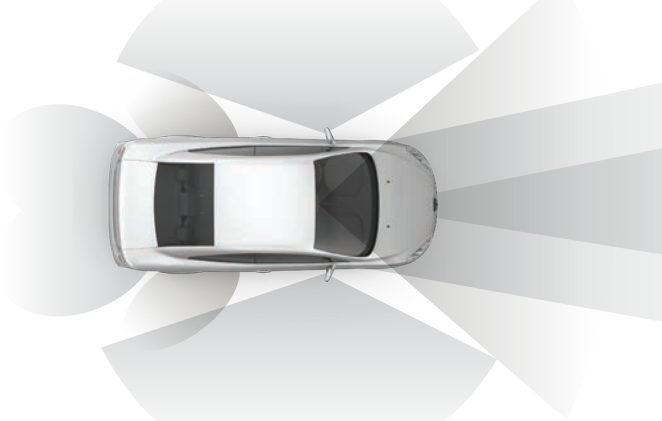

## STANDARD ALL SYSTEMS PART NO: AS20

- STANDARD CALIBRATION SYSTEM
- ACCESSORIES & LDW, AVM, NVS, ACC, BSD, LIDAR, RCW TARGETS
- ADAS CALIBRATION SOFTWARE
- REQUIRES MAXISYS TABLET SOLD SEPARATELY



## STANDARD ALL SYSTEMS +TABLET PART NO: AS20T

- STANDARD CALIBRATION SYSTEM
- LDW, AVM, NVS, ACC, BSD, LIDAR, RCW TARGETS
- ACCESSORIES
- MAXISYS MS909 TABLET
- MAXIFLASH VCI
- ADAS CALIBRATION SOFTWARE

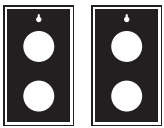
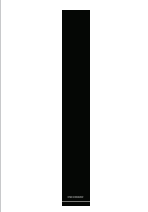
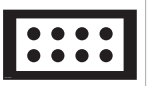
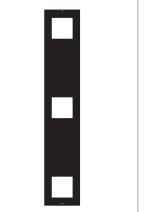
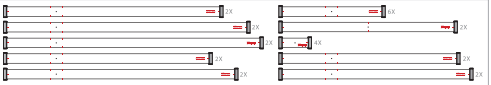
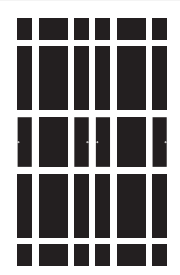
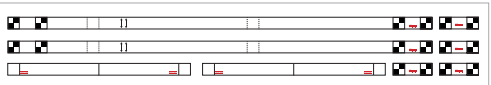

### AROUND VIEW MONITORING

					
VW AVM CSC0804/01	HONDA AVM CSC1004/02	HONDA AVM CSC1004/03	CADILLAC AVM CSC1004/06	TOYOTA AVM CSC1004/10	MITSUBISHI AVM CSC1004/09
					
				HYUNDAI/ KIA AVM CSC1004/04	



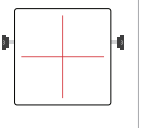
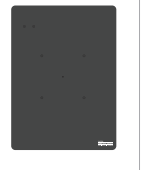

### NIGHT VISION SYSTEM

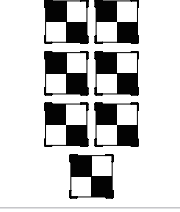
		
VAG/GM NV CALIBRATOR CSC0603/01	LEXUS NV PATTERN CSC0603/03	MERCEDES NV STAND CSC0803/01



### ADAPTIVE CRUISE CONTROL

				
ACC REFLECTOR CSC0602/01	RADAR CALIBRATION PLATE CSC0602/02	VW ADR CALIBRATION PLATE CSC0602/08	HITACHI RADAR PLATE CSC0802/03	NISSAN AVM CSC1004/11

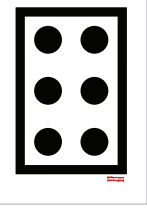

### BLIND SPOT DETECTION

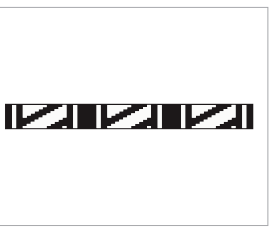
					
CENTER AXIS LASER CSC0500/04	RADAR CALIBRATION BOX CSC0605/01	CORNER REFLECTOR STAND CSC0800	CORNER REFLECTOR CSC0802/01	TARGET STAND CSC0802	HONDA LANEWATCH CSC0805/02

### LIDAR

	
VW/AUDI LIDAR CALIBRATION BOARD CSC0602/04	TOYOTA LIDAR REFLECTOR CSC0802/04

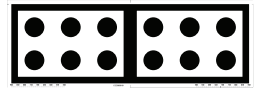
### REAR COLLISION WARNING

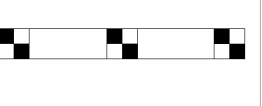
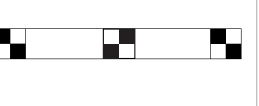
				
VW RCWI CSC0806/01	MERCEDES RCWI CSC1006/01	MERCEDES RCWII CSC1006/02	NISSAN RCWI CSC1006/03	NISSAN RCWII CSC1006/05



COMPACT



MOBILE



GLASS REPAIR



ADAS CALIBRATION

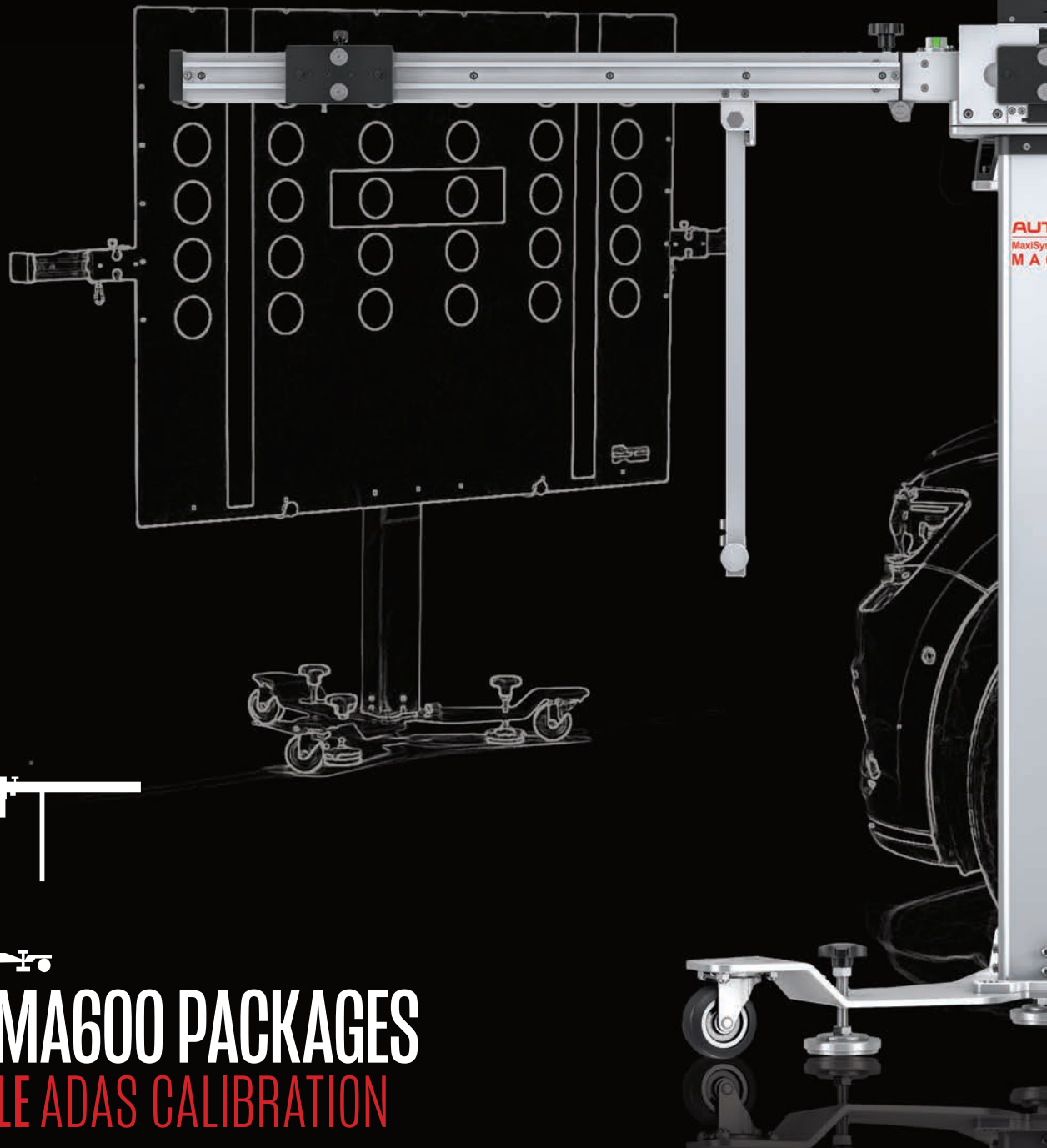

# ADAS MA600 PACKAGES

## PORTABLE ADAS CALIBRATION

The Autel MaxiSYS ADAS MA600 portable calibration system is ideal for multi-location shops. The compact frame, folds and disassembles to easily fit into the trunk of a car or service truck for easy transportation.

IDEAL FOR:



COMPACT



MOBILE



GLASS REPAIR



BODY SHOP



***FIND THE SYSTEM  
FOR YOUR SHOP***





MAXISYS  
MAG00  
CALIBRATION  
SYSTEM



## MAG00 LDW PACKAGES

EXPANDS LDW CALIBRATION CAPABILITIES

### MAG00 LDW PART NO: MAG0020

- MAG00 CALIBRATION SYSTEM
- ACCESSORIES & LDW TARGETS
- ADAS CALIBRATION SOFTWARE
- REQUIRES MAXISYS TABLET SOLD SEPARATELY

### MAG00 LDW +TABLET PART NO: MAG0020T

- MAG00 CALIBRATION SYSTEM
- LDW TARGETS
- ACCESSORIES
- MAXISYS MS909 TABLET
- MAXIFLASH VCI
- ADAS CALIBRATION SOFTWARE



MAXISYS  
MS909  
TABLET

### ACCESSORIES INCLUDED



DIGITAL TAPE MEASURE 1X



TWO LINE LASER 1X



L BRACKET 1X



FIVE LINE LASER 1X



PLUMB LINE 1X



LASER ASSISTED REFLECTOR 1X



LASER REFLECTIVE BOARD 1X



MOUNTING PLATE 1X  
\*AVAILABLE WITH ALL SYSTEM PACKAGES ONLY.

### LANE DEPARTURE WARNING

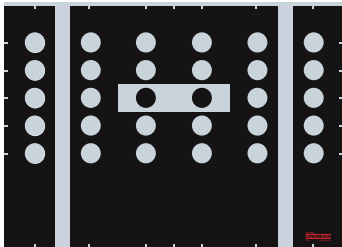

VW/AUDI/PORSCHE LDW  
CSC0601/01

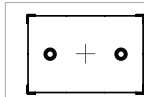

MERCEDES LDW  
CSC0601/02



HONDA/ACURA LDW  
CSC0601/05

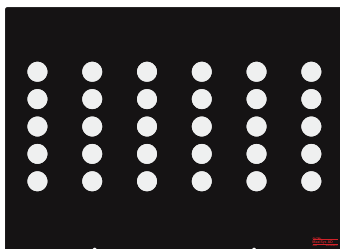

ALFA ROMEO LDW  
CSC0601/10

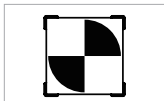

NISSAN/INFINITI LDW  
CSC0601/06-L

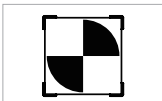

NISSAN/INFINITI LDW  
CSC0601/06-R

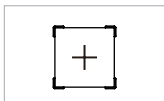

HYUNDAI/KIA LDW  
CSC0601/09



TOYOTA/LEXUS LDW  
CSC0601/11



MITSUBISHI LDW  
CSC0601/22-L

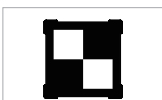

MITSUBISHI LDW  
CSC0601/22-R



SUBARU LDW  
CSC0601/14

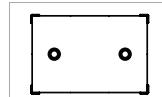

MAZDA LDW  
CSC0601/12

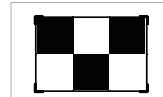

NISSAN LDWII  
CSC0601/03-L

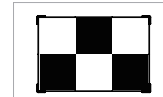

NISSAN LDWII  
CSC0601/03-R

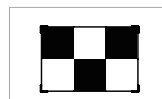

HONDA/ACURA LDWII  
CSC0601/08-L

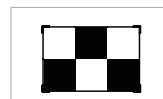

HONDA/ACURA LDWII  
CSC0601/08-R



TOYOTA/LEXUS LDWII  
CSC0601/15

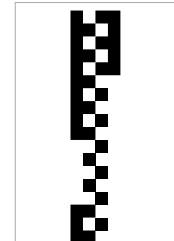

HYUNDAI/KIA LDWII  
CSC0601/07

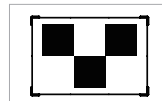

MAZDA LDWII  
CSC0601/13-L

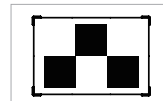

MAZDA LDWII  
CSC0601/13-R

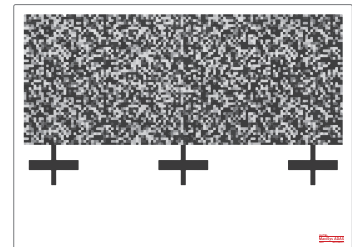

SUBARU LDWII  
CSC0601/17

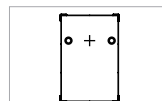

MERCEDES LDWII  
CSC0601/19



HONDA/ACURA LDWII  
CSC0601/24

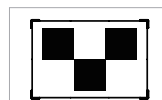

NISSAN/INFINITI LDWIII  
CSC0601/04-L

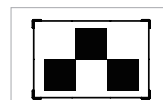

NISSAN LDWIII  
CSC0601/04-R

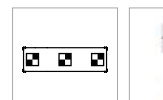

TOYOTA/LEXUS LDWIII  
CSC0601/25



HYUNDAI/KIA LDWIII  
CSC0701/23

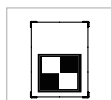

TOYOTA LDWIV  
CSC0601/11-01



# MA600 ALL SYSTEMS PACKAGES

THE ULTIMATE PACKAGES FOR CALIBRATION CAPABILITIES

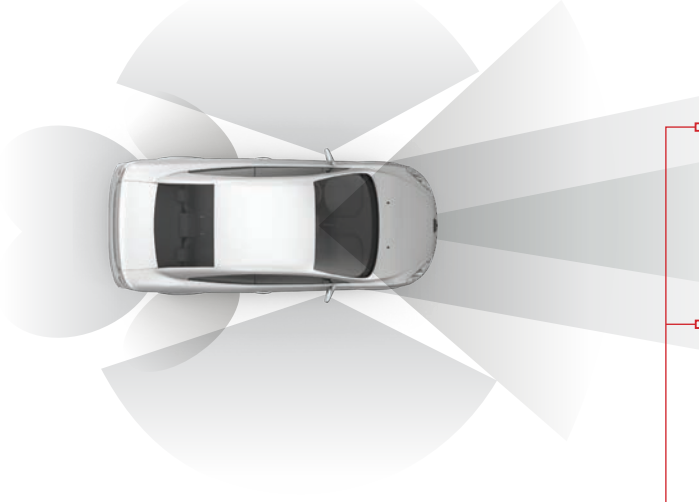

## MA600 ALL SYSTEMS PART NO: MAS20

- MA600 CALIBRATION SYSTEM
- ACCESSORIES & LDW, AVM, NVS, ACC, BSD, LIDAR, RCW TARGETS
- ADAS CALIBRATION SOFTWARE
- REQUIRES MAXISYS TABLET SOLD SEPARATELY

## MA600 ALL SYSTEMS +TABLET PART NO: MAS20T

- MA600 CALIBRATION SYSTEM
- ACCESSORIES
- LDW, AVM, NVS, ACC, BSD, LIDAR, RCW TARGETS
- MAXISYS MS909 TABLET
- MAXIFLASH VCI
- ADAS CALIBRATION SOFTWARE

### AROUND VIEW MONITORING

VW AVM CSC0804/01	HONDA AVM CSC1004/02	HONDA AVM CSC1004/03	CADILLAC AVM CSC1004/06	TOYOTA AVM CSC1004/10	HYUNDAI/ KIA AVM CSC1004/04	MITSUBISHI AVM CSC1004/09

### NIGHT VISION SYSTEM

VAG/GM NV CALIBRATOR CSC0603/01	LEXUS NV PATTERN CSC0603/03	MERCEDES NV STAND CSC0803/01

### ADAPTIVE CRUISE CONTROL

ACC REFLECTOR CSC0602/01	RADAR CALIBRATION PLATE CSC0602/02	VW ADR CALIBRATION PLATE CSC0602/08	HITACHI RADAR PLATE CSC0802/03	NISSAN AVM CSC1004/11

### BLIND SPOT DETECTION

RADAR CALIBRATION BOX CSC0605/01	CORNER REFLECTOR STAND CSC0800	CORNER REFLECTOR CSC0802/01	TARGET STAND CSC0802	HONDA LANEWATCH CSC0805/02

### LIDAR

VW/AUDI LIDAR CALIBRATION BOARD CSC0602/04	TOYOTA LIDAR REFLECTOR CSC0802/04

### REAR COLLISION WARNING

VW RCWI CSC0806/01	MERCEDES RCWI CSC1006/01	MERCEDES RCWII CSC1006/02	NISSAN RCWI CSC1006/03	NISSAN RCWII CSC1006/05

### FRAME ACCESSORY

MOUNTING PLATE FRAME ADAPTER FOR SELECT ACCESSORIES MA600RAP

# INTRODUCING THE NEXT STEP IN TABLET TECHNOLOGY | MAXISYS ULTRA ADAS TABLET



**AUTEL**  
MaxiFlash VCI

**SAE J2534**  
**RP1210**  
**ISO 22900**



## IA900 WHEEL ALIGNMENT SOFTWARE



Vehicle Inspection of Tires, Brakes, Suspension, Steering & More. Mark Service Recommendations, Attach Photos, Videos & Notes.



Live Alignment Reading Display. View All Alignment Results, Rear Only, Front Only, Chassis Symmetry, & Tire Diameter.



Illustrated Alignment Guide, Live Readings, Required Tools & Adjustment Locations Display on a Single Screen.

## COMES PRE-LOADED WITH THE NEWEST ADAS & WHEEL ALIGNMENT SOFTWARE

- Samsung Exynos 8895V Octa-Core Processor
- 4GB RAM & 256GB On-Board Memory
- 12.9 Inch Touch Screen
- 2 Cameras (Front & Rear)
- Plus Much, Much More!

### EXCLUSIVELY FOR USE WITH THE IA900WA

- IA900WA +TABLET PART# IA900WAT (PG. 8)
- IA900WA LDW +TABLET PART# IA900LDWT (PG. 8)
- IA900WA ALL SYSTEMS +TABLET PART# IA900AST (PG. 9)



## IA900 ADAS CALIBRATION SOFTWARE



The Industry's Fastest & Most Accurate Frame Placement with Target Position Validation.

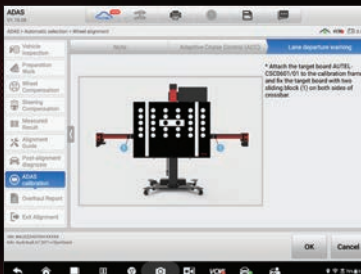

Step-By-Step Illustrated Full-Color Instructions Walk the User Through the ADAS Calibration Process.



Set ADAS Calibration Target Height with the Push of a Button.

# MAXISYS MS909 & MAXIFLASH VCI



### — FEATURES INCLUDE —

#### INTELLIGENT DIAGNOSTICS

- REPAIR ASSIST
- GUIDED DIAGNOSTICS

#### TOPOLOGY MODULE MAP

- ALL SYSTEM STATUS SCREEN
- COLOR CODED FAULTS

#### POWERFUL HARDWARE

- OCTA-CORE PROCESSOR
- 128GB MEMORY

#### AVAILABLE IN THESE PACKAGES:

- IA800 LDW +TABLET PART# LDW30T (PG. 12)
- STANDARD ALL SYSTEMS +TABLET PART# AS20T (PG. 17)
- IA800 ALL SYSTEMS +TABLET PART# AS30T (PG. 13)
- MA600 LDW +TABLET PART# MA60020T (PG. 20)
- STANDARD LDW +TABLET PART# LDW20T (PG. 16)
- MA600 ALL SYSTEMS +TABLET PART# MAS20T (PG. 21)



## NOW YOU CAN ADD ADAS SOFTWARE TO ANY COMPATIBLE MAXISYS TABLET

Autel ADAS Software features Full Color, Illustrated Instructions to guide you through each step of the calibration process. Adds comprehensive ADAS Pre & Post Scan Reporting for both Static and Dynamic Calibrations.



#### AVAILABLE IN THESE PACKAGES:

- IA900WA PART# IA900WA (PG. 8)
- STANDARD LDW PART# LDW20 (PG. 16)
- IA900WA LDW PART# IA900LDW (PG. 8)
- STANDARD ALL SYSTEMS PART# AS20 (PG. 17)
- IA900WA ALL SYSTEMS PART# IA900AS (PG. 9)
- MA600 LDW PART# MA60020 (PG. 20)
- IA800 LDW PART# LDW30 (PG. 12)
- MA600 ALL SYSTEMS PART# MAS20T (PG. 21)
- IA800 ALL SYSTEMS PART# AS30 (PG. 13)



Autel ADAS Software for the Standard & MA600 Frame System is compatible with the following Maxisys Tablets:

- MS908
- MS909
- MS908P
- MS919
- MS908S
- MSUltra
- MS908SP
- MS906PRO
- MSElite
- MS906PRO-TS

REQUIRES 64GB STORAGE MINIMUM

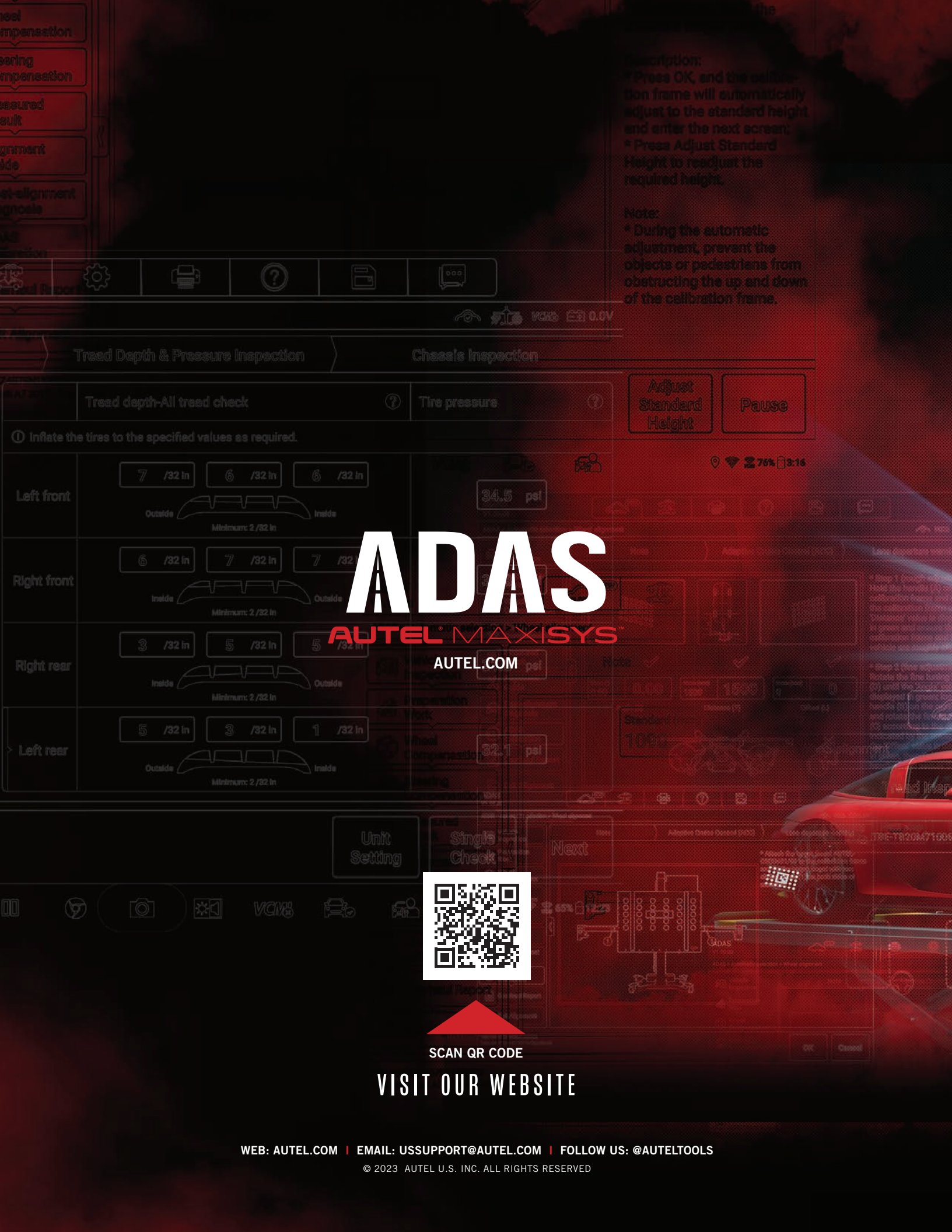

Description:  
 \* Press OK, and the calibration frame will automatically adjust to the standard height and enter the next screen;  
 \* Press Adjust Standard Height to readjust the required height.

Note:  
 \* During the automatic adjustment, prevent the objects or pedestrians from obstructing the up and down of the calibration frame.

# ADAS

AUTEL MAXISYS™

AUTEL.COM

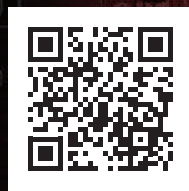

SCAN QR CODE

VISIT OUR WEBSITE

WEB: AUTEL.COM | EMAIL: USSUPPORT@AUTEL.COM | FOLLOW US: @AUTELTOOLS

© 2023 AUTEL U.S. INC. ALL RIGHTS RESERVED