



TIRE SERVICE INTERNATIONAL

Cabinet Truers 711 and 1200R



Read this manual before operating

Revised: November 2021

Safety Requirements

1. WARNING - WEAR SAFETY GLASSES
2. USE CAUTION! Machine is equipped with a very sharp rotating blade.
3. KEEP MACHINE CLEAN AND FREE OF DEBRIS
4. DON'T WEAR LOOSE CLOTHING
5. Training is advised prior to operating any Tire Truer. Due to physically shaving material from a tire - damage to the tire can occur and proper instruction is highly encouraged.
6. Only use Truer on clean tires completely free from debris. If truing used tires remove sand, stones and other foreign matter from tire tread. This includes on the rims and hubs.
7. Do not leave machine in use unattended.

Set Up Information

1. Provide 110-115 V, 60 Hz, single phase
2. Remove the machine from packaging materials. Special care should be taken when installing.
3. Be careful to not disturb preferences already set on machine.
4. Operate unit on a clean, level surface with room to maneuver. If Truer Cabinet is not level or sturdy, adjust the leveling screws to make the necessary changes until level. Maintain unit being level.
5. Read and follow all operating and safety instructions.
6. Cabinet Truers are primarily used for tires mounted on rims. These can range from 18 to 43 inches in diameter. As a Ring Lathe is another use.
7. Truing a tire is based on an accumulation of specific details and parameters. These details can be simple or complex. For accuracy and consistency start by bolting down the Truer on a clean, level surface and take advantage of the leveling feet on the machine.
8. General awareness: Keep the machine and it's associated parts and adapters free from damage and abuse. A Mandrel for instance, if bent to whatever degree can result in poor results when truing a tire. Bending a Mandrel slightly, say .020" off center can result in a substantial amount of excess rubber removal from a tire and it can ruin a tire.
9. The first step to "True" a tire is to select the proper Adapter that fits your wheel. Refer to Tire Truer Adapters Operating Manual. Whether you have a steel, aluminum or hub mounted tire you must use the proper Adapter. Please refer to the "Adapter Guide" to determine how to fasten your wheel onto the Truer Mandrel to place in the Bearing Saddle for Truing.
10. Once you make the proper Adapter selection you can proceed preparing the machine to True your tires.

Tip: Remember to use Tri-Wheel stand in Figures 5, 6 & 7 on page 5.

Operating Instruction Notes

Model 711: Primary Features

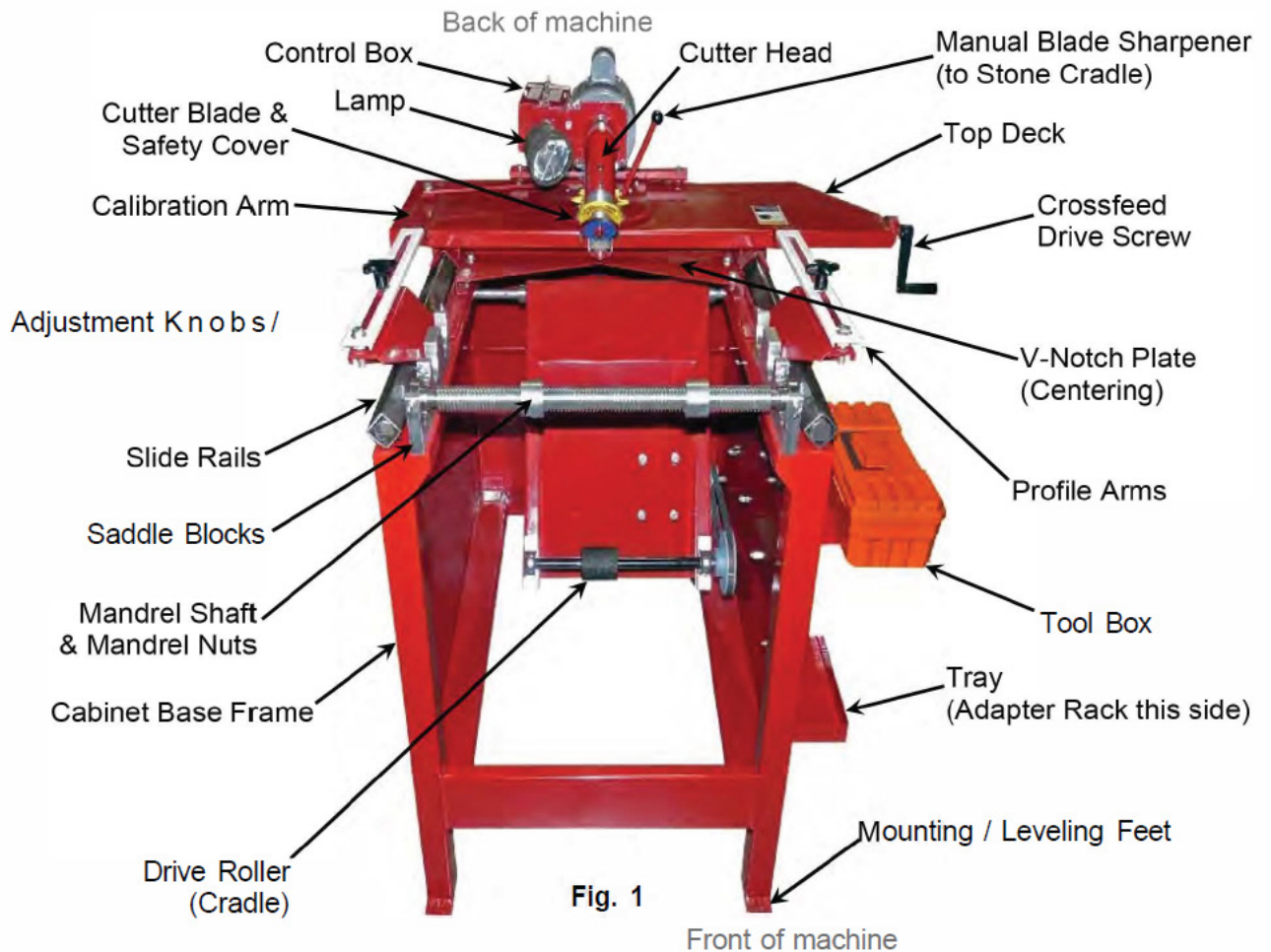

Operating Instruction

Model 1200R: Primary Features



Like the model 711 unit many features are the same. Refer to page 2 for common features. Please note the main differences are how the Top Deck is mounted and how it functions.

Back of Truer Cabinet (All Models)



Drive Roller Screw

Infeed Drive Screw

Model 1100: Primary Features

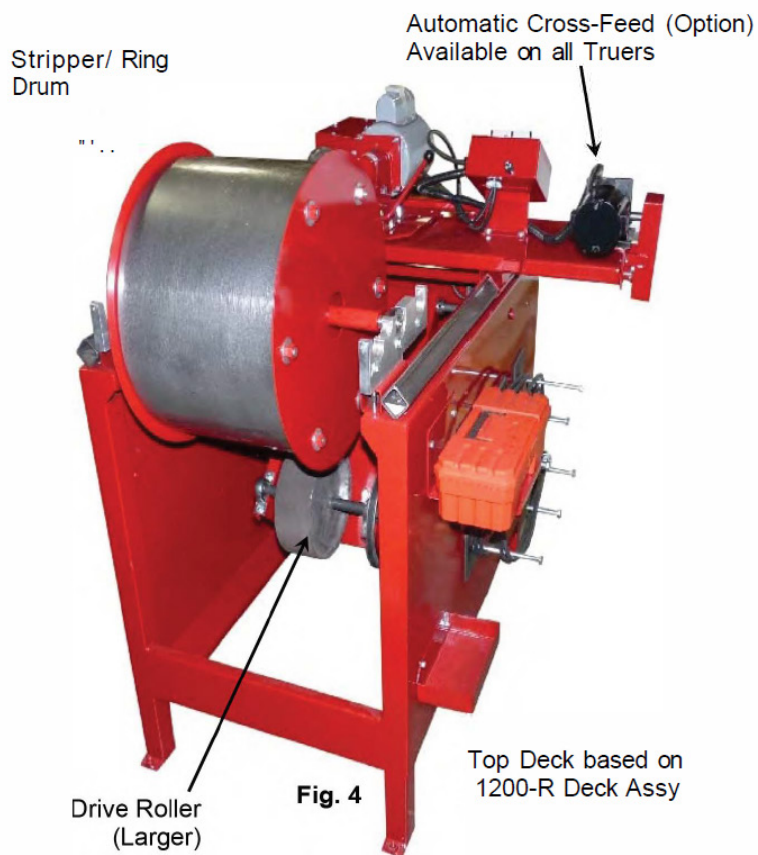

General Notes

Why "True" a tire?

1. Tire truing is performed to eliminate poorly balanced tires, wheel skip, reduces balancing weights, cupping and extend tire life and performance. It also helps reduce wear and tear on suspension systems.
2. The goal for Truing tires is to make tires round (from the center out) and to make the tread surface either flat to the road or with a perfect profile all the way around a tire. In general not all tires are round. Once you mount a tire on a Tire Truer and rotate it you'll see just how far out of round tires really are.
3. With that in mind the accuracy of creating a round tire is in the hands of each Tire Truer Operator.
4. The more aware and skilled an operator is the better the result in making a tire round.
5. Another key factor is to remove as little tread as necessary. Removing too much can gouge a tire during truing. It can also unnecessarily decrease the tire life.

What to choose: A model 711, 1200-R or 1100?

6. The 711 makes a profile cut.
7. To cut a flat and/or specific angle on the tread surface use a 1200-R unit.
8. The 1100 is used as a Stripper Ring Lathe (non automotive usage.)
9. Parked vehicles develop a flat spot on the tires. DO NOT true a tire without warming the tires or driving the vehicle to remove the flat spot. We recommend using our model 975 Tire Warmer for this purpose or driving the vehicle at least 4 miles before removing and truing the tires.

Operating Instructions

Loading tire into machine: This applies to model 711 & 1200-R Truers

1. Move Top Deck assembly to furthest position away from Mandrel Shaft location (see Fig. 1 on page 2.) Shown is the Top Deck moved back away from the Saddle Blocks.
2. Loosen the Adjustment Knobs on the Profile Arms and spread them apart when doing this. This will prevent the tire from accidentally ramming into the cutter blade when the tire, Mandrel Shaft and Adapter assembly is loaded into the Saddle Blocks on the machine.
3. When placing tire and Mandrel Shaft assembly in the Saddle Blocks pick the bearing seat location closest to the Cutter Blade without the tire contacting the blade.
4. The set screws on one of the bearings should be tightened firmly on the Mandrel Shaft. Use the other bearing and set screws as an adjustment feature to expand the Mandrel Shaft and bearing assembly between the Saddle Blocks.



Fig. 8: A close-up of the Mandrel Shaft, a Bearing and Set Screw, the Saddle Block and Thumb Screw with the Bearing tight against the Washer Stop in the Saddle Block.

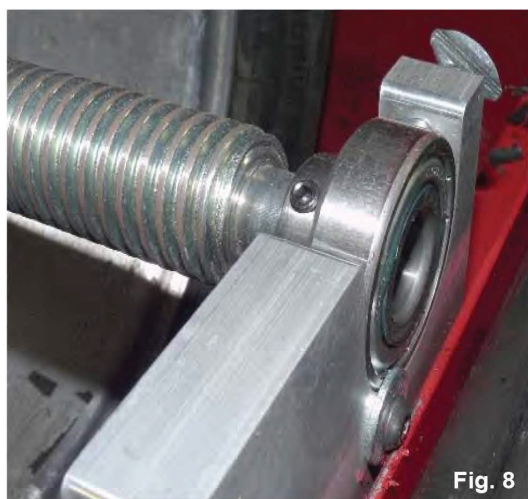

1. Tighten Bearing set screws and Thumb Screws in Saddle Block on both sides.
2. Spin the tire. The tire needs to rotate perpendicular to the Mandrel Shaft. Severe damage to a tire can occur if attempting to True a poorly mounted tire.
3. **Check for run-out and concentricity to the Mandrel Shaft before Truing!**
4. If necessary make adjustments and check for debris which could cause for poor mounting.
5. Double-check that the tire rotates evenly on the Mandrel
6. Shaft and Bearings before proceeding.

Adapter Information

1. This guide will explain the application, use and purpose of Amermac Tire Truer Adapters.
2. Primarily there are two types of Tire Truer Adapters:
 - A. **Bolt Centric:** Used when the bolt circle of a rim centers a tire.
 - B. **Hub Centric:** When the center hole of the rim pilots the tire center.

Tire Truer Adapters A 1 - A6



A1



A2



A3

Center Shaft outside diameter is 1.75" on A 1 - A5



A4



A5



A6

Above are Bolt Centric adapters with 34 bolt patterns. The set can be used on over 1000 makes and models of cars, light trucks and sport utility vehicles.

Choosing a Bolt Centric Adapter

Tire Service International has developed a TRUER ADAPTER CHART, shown on the next page (see fig. 4 on page 7.) The chart is based on bolt circle diameters and the number of lug nuts or wheel studs for each rim type.

For example:

Finding an adapter to use for a 5-lug, 4.500" diameter bolt circle look in the # of Lugs column, go down to 5 Lugs and look for the bolt circle diameter listed in the next column. Find the Adapter Name, in this case "A2." The part number for this is 6381 and the pattern to use is 3. Fig. 3 (at right) shows numbers stamped near each threaded hole that correspond with each adapter and the various bolt circle diameters listed on the chart.



Truer Adapter Chart

# of Lugs	Bolt Circle inch	Bolt Circle mm	Adapter Part Number & Pattern	Adapter Name	Measurement Driven	Notes
3 or 6	3.500	88.90	6382-1	A4	inch	
3 or 6	4.000	101.60	6382-2	A4	inch	
3 or 6	4.500	114.30	6382-3	A4	inch	
3 or 6	4.53	115.00	6364-1	A3	mm	
3 or 6	4.72	120.00	6364-2	A3	mm	
3 or 6	5.000	127.00	6382-4	A4	inch	
3 or 6	5.197	132.00	6364-3	A3	mm	
3 or 6	5.315	135.00	6364-4	A3	mm	
3 or 6	5.500	139.70	6382-5	A4	inch	
3 or 6	6.000	152.40	6382-6	A4	inch	
3 or 6	7.000	177.80	6382-7	A4	inch	
3 or 6	7.087	180.00	6367-3	A6	mm	
3 or 6	8.250	209.60	6367-4	A6	inch	
3 or 6	8.858	225.00	6367-5	A6	mm	
4 or 8	3.940	100.00	6366-1	A5	mm	
4 or 8	4.250	108.00	6366-2	A5	inch	
4 or 8	4.500	114.30	6366-4	A5	inch	
4 or 8	6.500	165.10	6367-1	A6	inch	
4 or 8	6.690	170.00	6367-2	A6	mm	
5	3.940	1,100.00	6362-1	A1	mm	
5	4.000	101.60	6381-1	A2	inch	
5	4.250	108.00	6381-2	A2	inch	
5	4.331	110.00	6362-2	A1	mm	
5	4.410	112.00	6366-3	A5	mm	
5	4.500	114.30	6381-3	A2	inch	
5	4.530	115.00	6362-3	A1	mm	
5	4.720	120.00	6362-4	A1	mm	
5	4.750	121.00	6381-4	A2	inch	
5	5.000	127.00	6381-5	A2	inch	
5	5.118	130.00	6362-5	A1	mm	
5	5.315	135.00	6362-6	A1	mm	
5	5.500	139.70	6381-6	A2	inch	
5	5.906	150.00	6366-5	A5	mm	
5 or 10	8.859	225.00	6367-6	A6	mm	Use 3 holes

Fig. 4

Please note: Bolt circle diameters are listed in both inch and millimeter increments.

Used on Cabinet Truers these mount on a 1-1/4" diameter mandrel shaft with spacers and locking mandrel nuts (shown later.)

Bolt Centric Instructions

1. Select the correct Adapter and place it on the Tri-Stand (Fig. 6.) Put the tire on it and line-up the holes in order to fasten them together using the supplied Hex Bolts (see photo insert.)
2. Hand tighten making sure the mating surface between the two have no gap. **Tighten when on the mandrel shaft using the mandrel wrenches.**
3. Figures 7 & 8 show a mounting variation. Using the front or back of the Adapter is acceptable as long as the end result can center the tire tread to the Cutter Blade.
4. See Fig. 9 showing Spacers (photo insert) being used along with the Mandrel Nuts and Shaft Bearings.



1. More experienced operators may opt to assemble the Adapter and Mandrel Shaft parts together, place it into the Tri-Stand and simply mount the tire to it.
2. **The key is selecting the correct Adapter without having to put it all together, then take it apart and re-assemble it.**
3. Heavier tires may not allow for this so both methods are shown.
4. Once assembled place into a suitable Pillow block groove (fig 10). Take play out of the mandrel shaft & bearings and tighten bearing set screws. Once position tighten thumb screws. Center the tire tread with cutter head.
5. Proceed by tightening the mandrel Nuts and adapter assembly
6. You are now ready to true the tire.

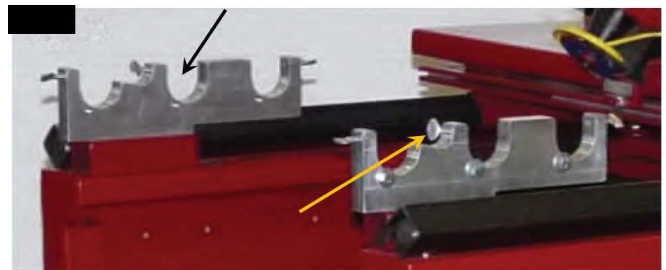

Hub Centric Instructions

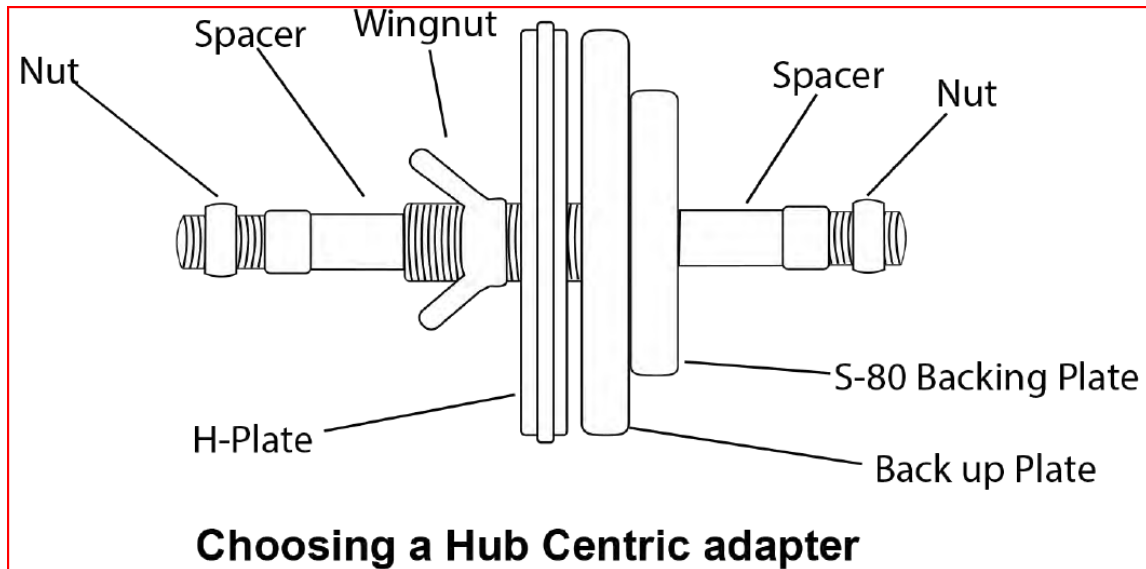

1. The Amermac Group H series adapters (see Fig. 11 below) are based on the center inside diameter of a rim. These adapters used along with the Series 80 Backing Plate and Wing Nut (Fig. 12 below right) are generally used for Truing medium to large truck tires.
2. The adapters have a part name and sizes (usually in millimeters) stamped on them. Both sides of these adapters are machined to one or more bore sizes. Measure the inside diameter of the rim, convert it to millimeters and select an adapter that fits tight, in relation to the tire.
3. **Cleaning the rim surface where the adapter and backing plate mount is critical.**



1. Fig. 13 shows a picture of a Hub Centric Amermac Adapter.
2. Don't force onto a rim. Measure carefully and make sure the rim is clean. A spacer/backing plate PN HBP001 can be used with series 80 backing Plate & wing nut.
3. Sandwich the wheel between these plates and tighten.
4. When Truing any tire make sure all debris is removed from the entire wheel!
5. If as much as a pebble is trapped between these parts when they're sandwiched together the outcome will ruin tire. If necessary using a wire brush, sand paper or even emery cloth to prepare the rim is time well spent.
6. Remember, Tire Truing is for making uneven, cupped or damaged tires round.

Hub Centric Instructions

1. Many of the same principles of using the Bolt Centric Adapters apply to the Hub Centric Adapters. The end result is to have the tire and rim mounted to an adapter, on the Mandrel Shaft and ultimately centered to the Cutter Blade on the machine.



Fig. 14

2. Rather than mounting the rim to an Adapter the Adapter is fitting inside the center opening of a rim and sandwiched together between Backing Plates or spacers.

3. Wheel preparation is critical. In Fig. 14 a rim is shown with dirt and rust on it. Clean it off or you'll end up paying for it later.

4. It can't be stressed enough to select the right adapter that fits properly in the center hole of the rim. If there's too much tolerance the tire can become damaged or ruined.

5. In Figures 15 & 16 a Group H adapter has been selected and mounted to a truck tire using the Series 80 Backing Plate & Wing Nut.

6. Assemble the Mandrel Nuts, Spacers on the Mandrel and align with Cutter Blade.

**PROPER EYEWEAR AND FOOT PROTECTION
REQUIRED AS WELL AS NO LOOSE CLOTHING**

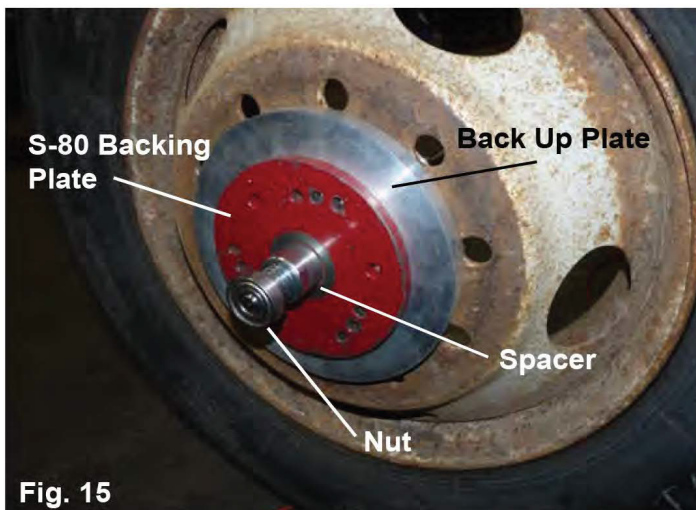

Fig. 15

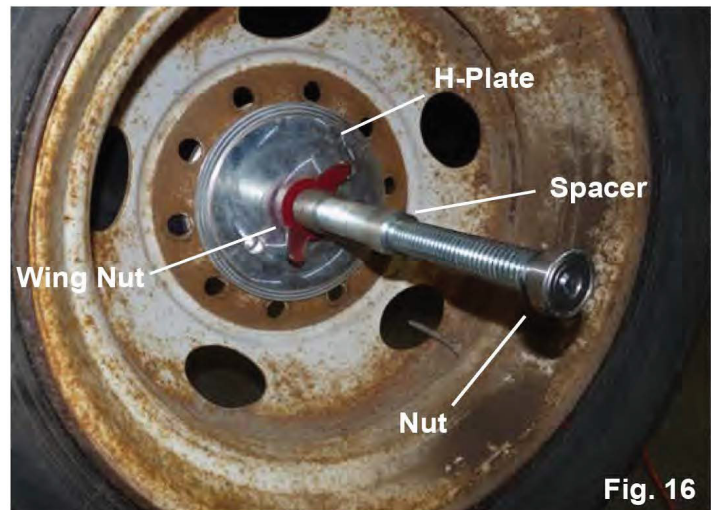

Fig. 16

1. The same applies when locating the tire and adapter assembly on the Truer. Select the appropriate Pillow Block location, tighten set screws in the Mandrel Bearings and tighten thumb screws. Once positioned tighten the Wing Nut and Mandrel Nuts.

2. Something to note: In Figures 15 & 16 a rustier rim was used to show that even in certain conditions Truing can still be achieved. Prior to Truing this wheel emery cloth and sand paper were used to clean the bore and contact surfaces of the rim. TSI recommends checking each Mandrel Shaft for straightness fairly often.

TSI recommends checking each Mandrel Shaft for straightness fairly often.

711 Operating Instructions

Centering

1. The tire must be centered to the machine. Slide out the V-Notch Plate centering gauge located under the Top Deck to center the tire (see Fig. 12 below). If properly centered both sides of the tire will touch the V-Notch equally. If not loosen the Mandrel Nuts and center the tire. Make adjustments then tighten mandrel nuts using the Mandrel Wrench.
2. After tire is centered slide the V-Notch Plate out of the way under the Top Deck

Clean tire tread of sand, grit, pebbles and all debris before truing.

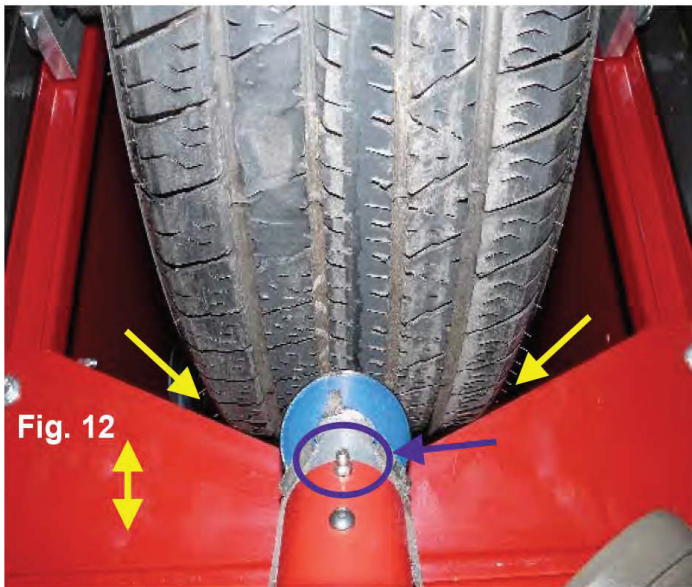

Move Top Deck back a little so Cutting Blade isn't contacting tire.



Set Calibration arms to 24.

Tire Truing

Clean tire tread of sand, grit, pebbles and all debris before truing. Loosen the two clamping knobs and position the top deck to 24 then tighten both clamping knobs. As you become more experienced you may wish to change the setting on the calibration arm.

Use the Infeed Drive Screw to advance the Cutter Blade close to the tire. Rotate the tire by hand and see how much the tire is out-of-round.

711 Operating Instructions

Tire Truing (Continued)

1. Turn Drive Roller ON and raise it to engage with the tire (Fig. 13) by turning the Drive Roller Screw located at the rear of machine. It's spring loaded so no need to force it.
2. Lift Blade Safety Guard (Fig. 14) and turn Cutter Blade switch ON in the direction which truing is to be performed. We suggest truing the right half of the tire tread first. Start at center and move right. Make sure Cutter Blade is razor sharp before each pass.
3. Turn on Lamp and adjust it to shine directly where you're cutting.



4. Turn the Infeed Drive Screw with the Cutting Gauge on it (in back of unit, see Fig. 15) to advance the blade until it barely starts cutting.
5. **Observe how much the tread is out-of-round to determine the depth of the cut.**
6. Grip the Infeed Drive Screw (keep it from turning) & turn the slip-wheel Cutting Gauge to set to zero. For example, /aterwhen you turn the Infeed from Oto 20 on the Cutting Gauge you could take a .020" deep cut into the tire. At the end of each cutting pass you'll be backing the Cutting Blade away from the tire so setting this at zero establishes a starting point to return to



- upon going back to tire center to do the other half of each tire.
7. The Cutter Gauge measures the depth of cut.
8. Turning it one full revolution makes the Cutting Blade move 1/8" (.125") into or away from the tire.
9. In no case should a single cut be more than 1/32" in depth. Basically from Oto 3 on the Gauge, which is .030 inches. Still, we suggest starting with a .020 inch cut.
10. There's marks all the way around the Gauge so if one forgets to pre-set the Cutter Gauge, you can always use somewhere on the dial for a starting reference point. Between each mark = .005"

11. The Cutting Blade is specially hardened but will become dulled by embedded objects in the tread. To insure a clean, smooth job sharpen when necessary.

12. Blade life depends on the operator almost as much as the differences in rubber from one brand to another. A blade will last longer on newer tires as opposed to tires with pebbles or debris not cleaned properly from the treads.

711 Operating Instructions

Please note: The Cutting Gauge wheel and adjustment techniques are the same for all Cabinet Tire Truers. If the slip adjustment feature on the Cutting Gauge is too loose, mildly tighten the set screw on it. Fig. 15 on page 12.

**KEEP HANDS AWAY FROM SPINNING
TIRE AND CUTTING BLADE**

The Cut

1. At this point your machine should be ON. The Roller Drive should be spinning the tire, the Lamp should be ON and the Cutter Blade should be making a .020" deep cut into the center of the tire.
2. Using the Crossfeed Crank on the Top Deck slowly traverse the Top Deck & Cutting Blade across the right half of the tread. This cut will be a perfect profile of the original tread in accordance with the setting of the index on the Profile Arm (Fig. 12.) Notice the Motor Assembly and Cutting Blade pivoting slightly to match the profile of the tire.

KEEP CUTTER BLADE RAZOR SHARP - KEEP THE CUTTING AREA CLEAN

3. Observe the rate of speed you're moving the Top Deck and how consistent your cut is being made. Go faster or slower to suit the desired end-result.
4. Upon completing the end of your first pass on the tread, back the Top Deck and Cutting Blade away from the tire using the upper crank handle. Be careful not to lose where your 'zero' setting is. Turn the Cutter Blade Motor OFF.
5. Reposition the Cutter Blade location at the center of the tire where you first started. Turn the Cutter Blade Motor ON, this time Reverse the motor direction by toggling the switch toward the new direction of truing. Set your cut and proceed to do the left side of the tire.
6. We highly recommend Truing both sides of the tire in stages for each change of depth in the tire before making the final cut. Slowing down traversing the Top Deck results in a smoother end result.
7. It is possible a novice will prefer repeating the operation several times by taking lighter cuts until all the high spots in the tread have been removed. After many tires an operator can gain more confidence, skill and a better understanding of what the machine can do.
8. When the tire is complete, turn OFF the Motors, lamp and remove the tire and Mandrel assembly, then remove tire from Adapter.
9. While Truing make sure tire position doesn't change.
10. The Mandrel Shaft, Bearings and Thumb Screws as well as the wheel mounted on the Adapter need to be secure at all times. This includes the Profile Arms, Knobs and linkage assembly.
11. This completes the truing operation for a standard model 711 unit.



For Autofeed instructions see Electric Controls on page 11 of this manual.

1200R Operating Instructions

1. See Page 5 for tire mounting instruction. Load tire in either of the two furthest Saddle Block locations from Cutter Head and tighten Thumb Screws (Fig. 5-8.)
2. Position Cutter Head at mid-tire. Crossfeed left and right to verify tire being parallel with Top Deck.
3. Set the Top Deck to zero angularity. Loosen the knob (see Fig. 17) under both sides of the Top Deck and align the two flat steel pivoting plates under the Top Deck.
4. Fig. 18 displays the location of the Calibration Mark Decal on the back left-hand side of the unit under the Top Plate. Another decal is on the right side. Use these to establish a consistent cut angle on the tire.
5. For specific details describing how deep a cut is being made per a given angle and tire width please refer to the 1200-R Tire Truer Calibrations Bulletin.
6. Proceed to Flat Cut or Angular Cut once you have a tire mounted and ready to go.



Fig.17

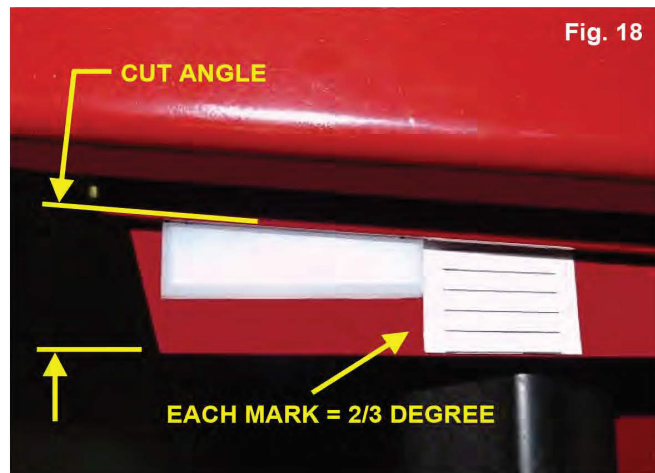

Fig. 18

Flat Cut

1. Consider the end result of the tire. If the cut is flat you can proceed by setting the depth desired. Engage the Drive Roller and prepare the Cutter Blade as stated on Page 12, Fig. 13 & 14.
2. Position the Cutter Head to one side of the tire and begin your cut. The same cutting parameters listed on page 12, referring to Fig. 15 cutting .020" or (1/32" maximum) apply.
3. Instruction on The Cut (page 13) applies here with the exception of not using the tire center for repositioning the Cutting Blade. For finer cuts* remove less rubber material on the final pass and slow down the speed of the Cutter Head traversing speed.
4. *Manually sharpen the Cutting Blade more often if necessary.

KEEP CUTTER BLADE RAZOR SHARP - KEEP THE CUTTING AREA CLEAN

Angular Cut

5. The degree Calibration Marks on 1200-R Truers have long been referred to as being in increments of 1°. It's been determined the actual angle between each mark is about two-thirds of a degree.

Which is measurable considering each angle on a 10 inch wide tire being Trued from the center out ends up having between 1/16 and 1/8 inch rubber removed from each edge.

1200R Operating Instructions

Angular Cut continued

1. Center tire to Cutter Blade and determine what angle* cut will be made to the tire. Pivot the Top Deck to set your angle using the Calibration Marks (Fig. 17 & 18) and tighten both knobs under the Top Deck.
2. Cut the rubber from tire in increments no greater than 1/32" maximum (.020 inches is suggested.) It's up to the operator whether to start from left to right or right to left.
3. * Please refer to the 1200-R Tire Truer Calibration Guide and review the impact of tire width, angle of cut and material being removed to help determine what actually is the end result you're looking for.

Angles starting not on-center with the tire

1. This can also be achieved by applying the same criteria as listed above in the Angular Cut directions. The variable being where to identify the highest pitch of the tire (new angled tire center) is to be. It's advisable to measure and mark the tire in relation to the centered Cutter Blade along with indicating where the tire mounted to an Adapter is mounted on the Mandrel Shaft, so duplicating the application can be more consistent.
2. When the tire is complete, turn OFF the Motors, lamp and remove the tire and Mandrel assembly, then remove tire from Adapter.

1100 Operating Instructions

1. The 1100 model Truer functions and operates similar to the 711 and 1200R machines. With this in mind the only difference in operation is the Drive Roller wheel size powering the Ring Stripper Drum and cutting speed necessary for a smooth finish.
2. Variable Drum sizes are available depending on the product being turned.
3. All other instructions given for the 711 and 1200-R must be followed.
4. Only tighten nuts and bolts on Ring Stripper Drum firmly. Don't bend the end plates.

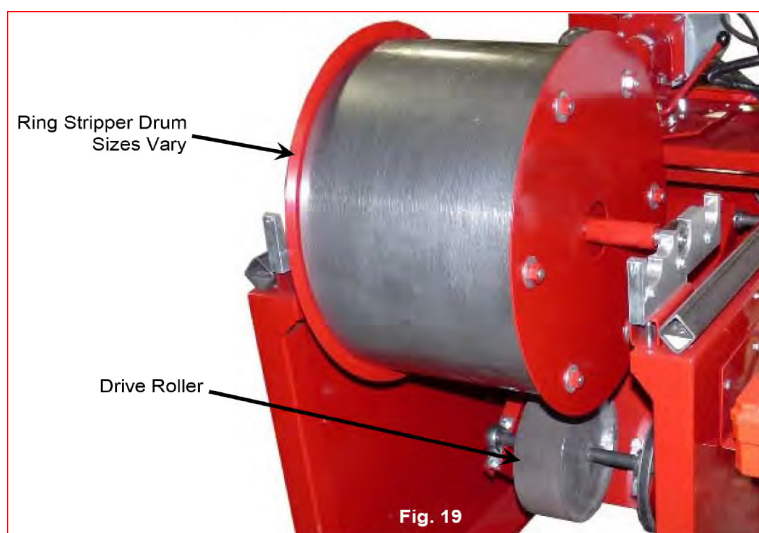

Electric Controls - All Units

Control Box - Standard

1. Below in Fig. 20 is the standard Control Box. A 3-position toggle-switch is used to operate the Cutter Blade. Likewise a switch for each the Drive Motor and Lamp.
2. The directional switch for the Cutter Blade is marked with clockwise and counter clockwise arrows. The blade should always be turning in the direction of Deck travel. Always stop the blade before changing direction of the switch.

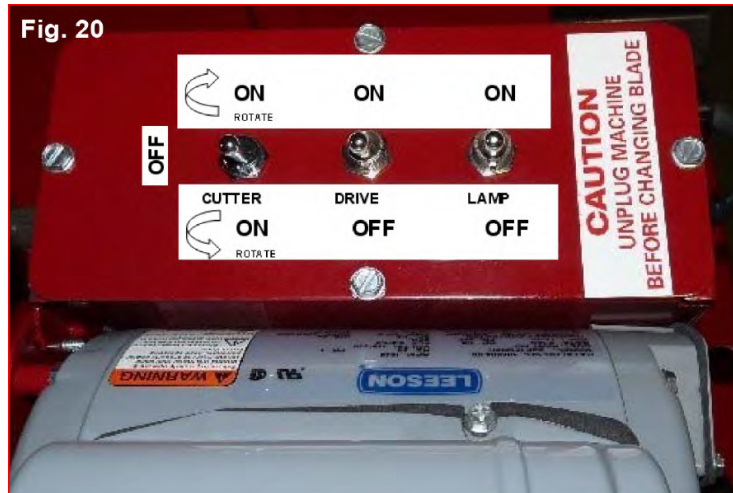

Control Box - Autofeed Option

1. Below is the Autofeed Control Box (Fig. 21.) Note the addition of the Crossfeed Direction Switch and Speed Control Adjustment knob.
2. These control the direction of the Top Deck and the speed in which it moves the Cutter Blade across the face of the tire. The Speed Control varies from 0 RPM to a faster RPM.



Truer Maintenance

Maintenance - Based on Truing approximately 100 tires a week.

Daily

1. Keep the machine clean. Remove rubber chips and debris with a brush or air nozzle. Too much accumulated debris can complicate operation of machine as well as add to hazardous working conditions. We recommend cleaning working contact areas after each tire or ring trued.
2. Check Blade and Sharpening Stone. Refer to Cutter Head Repair Parts List to order.
3. Make sure Mandrel is straight. If it's not straight the result on truing a tire incorrectly is magnified considerably. Maintaining straightness is essential.
4. Verify Blade Safety Cover is operational.

Weekly

1. Lightly oil and lubricate all working surfaces such as slide rails, drive screws, pivot points, gears and contacting movable parts for longer product life and smoother operation with a silicone solution. It should offer corrosion protection, metal wetting, water displacement and penetration to surfaces it's applied to. Depending on use it may be necessary to lubricate more often than weekly.
2. Clean and visually check Adapters for wear and tear.

Monthly

1. Add standard chassis grease to zerks on Cutter Head and Flange Bearings.
2. Check belt wear. Total belt deflection when tight is 1/4" to 3/8" midway between pulley's.

Cutter Blade & Grinding Stone Service

1. TSI suggests installing a new stone with each new blade. This will provide proper seating of the stone to the blade, will extend the life of the blade and give better sharpening.

To change Cutter Blade

1. In Fig. 22 use Spanner Wrench (Fig. 23 & 24) and Allen wrench to remove the Cutter Blade.
2. Simply loosen the Socket Head Cap Screw while inserting the Spanner Wrench into the Blade to keep it from turning. Loosen and remove the Screw and Cap, then remove the Cutter Blade. Before installation of the new Cutter Blade replace the Grinding Stone.



Fig. 22

**BE VERY CAREFUL WHEN HANDLING
OR CHANGING CUTTING BLADE!
UNPLUG FROM POWER**

Once replaced
tighten blade to
30-40 ft-lbs and
stone to 15-20
ft-lbs.



Fig. 23

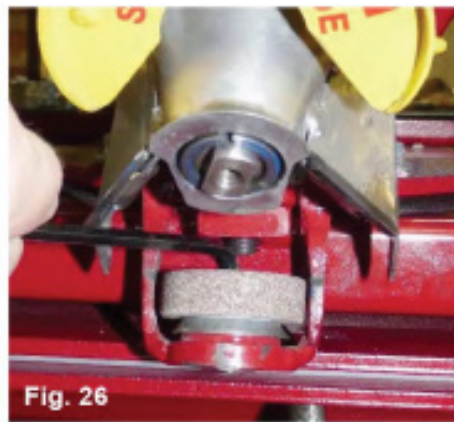
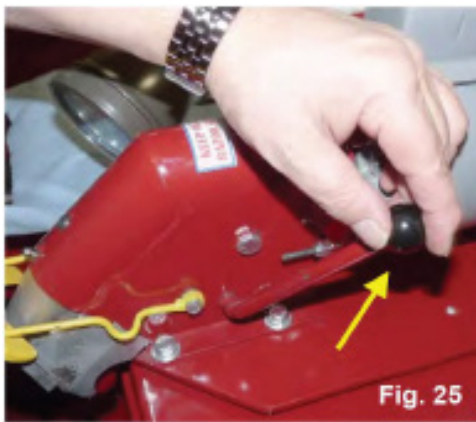

Fig. 24

Truer Maintenance

Changing Stone

1. Lift the manual blade sharpening lever in Fig. 25 to lower stone cradle. As supplied with each unit, work the short ended Allen Head Wrench into the Stone-Bolt Hex, Fig. 26.
2. While holding the Allen Head Wrench in place, let go of the manual sharpening lever, then insert the Special Socket into the bottom of the Stone Cradle (see Fig. 27) to make contact with the Jam Nut. Loosen and remove the old Stone and Paper Washers. In reverse order replace the Stone and Paper Washers. Tighten securely so there's no play left between the Stone in the Cradle and the Bearing housed in the Grinding Stone Cradle.
3. For the Stone replacement make sure to replace the Paper Washers. These are shipped with replacement blades and stones when ordered.
4. Remember, there should not be any "wobble" of the Stone if the nut is securely tightened.



BE VERY CAREFUL WHEN HANDLING OR CHANGING CUTTING BLADE!

When replacing the Cutter Blade make sure the spring loaded Carbide Blades are firmly against the back-side of the Cutter Blade (see yellow arrow in Fig. 28.) Use the Spanner Wrench, Fig. 23 to tighten Cutter Blade.

Once Cutting Blade and Stone have been replaced recheck your work. Upon everything being properly replaced run the unit to sharpen and 'seat' the new Stone and Cutting Blade to each other.

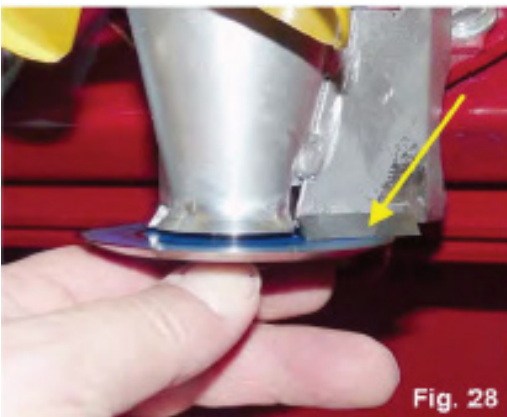

Sharpening

Fig's 29, 30 and 31 are various stages of sharpening the Cutter Blade. Using lever (Fig. 25) lift the Stone to make contact with the Cutter Blade. Grind on it for a few seconds then release so blade can briefly cool and debris can clear itself.

Don't burn edge of blade with continuous grinding.

Truer Maintenance



Fig. 30

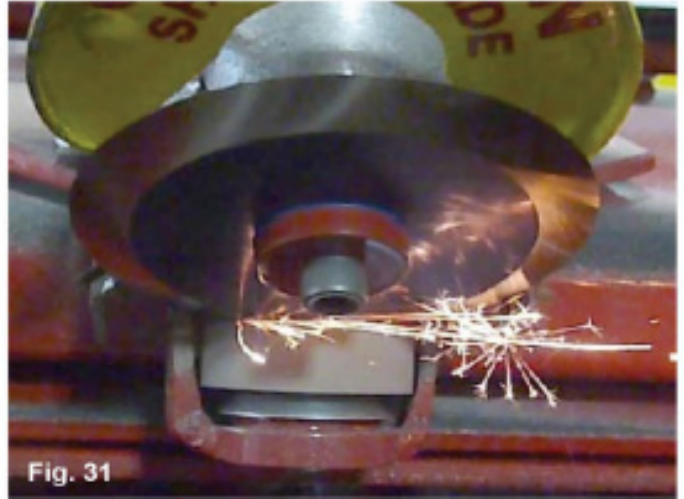

Fig. 31

Repeat the grinding and releasing process until the blade is razor sharp

Machine maintenance is vital to maintain its accurate cutting ability. If parts on the machine are broken, damaged or loose it CAN cause damage to a tire.

Address those situations promptly.

TSI is not responsible for careless operation and use of these machines or the damage that could incur due to improper use and operation.

Grease zerks locations: Fig's 32 to 35. Also Fig. 12 on Page 11.



Fig. 32



Fig. 33

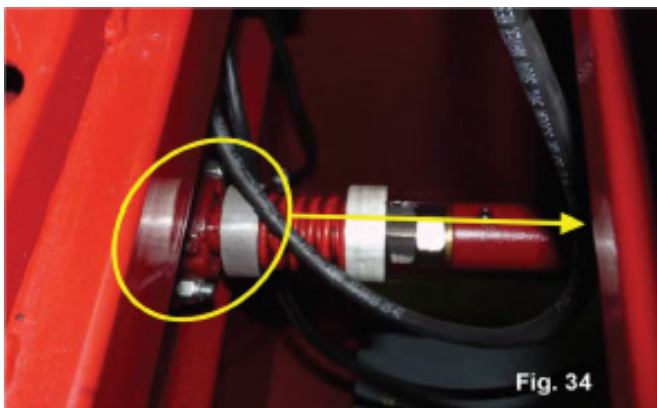

Fig. 34



Fig. 35

Tire Truer Adapters

Reference chart for wheel lug/bolt patterns on passenger cars & trucks both foreign and domestic. There are some vesicles not listed here. Contact TSI if seeking an adapter not on this list or an adapter for older vehicles.

FEATURING 1-3/4" bore on A1 thru AS

TSI ADAPTERS:

- A2 - 6381 Wheel Adapter, 5 Lug Inch
- A3 - 6364 Wheel Adapter, 3 Lug Metric
- A4 - 6382 Wheel Adapter, 3 Lug Inch
- AS - 6366 Wheel Adapter, Multi
- A6 - 6367 Wheel Adapter, 4 & 5 Lug

L = Low Offset or RWD (Rear wheel drive) Typically O offset

M= Medium Offset or RWD (Rear Wheel Drive) Typically +20 offset

H= High Positive o FWD (Front Wheel Drive) typically +45,40, 35 offsets

MODEL	YEAR	SIZE	BOLT PATTERN	STUD SIZE	HOLE	OFFSET	ADAPTER	Or
CL	1998-00		4 x 4.5" (114.3mm)	12mm x 1.5	64.1	H	A5/PN 6366-4	TSI PN 15391 #4
CL	2001-03		5 x 4.5" (114.3mm)	12mm x 1.5	70.3	H	A2/PN 6381-3	TSI PN 15392 #3
CL/CLS	2004-05		5 x 4.5" (114.3mm)	12mm x 1.5	70.3	H	A2/PN 6381-3	TSI PN 15392 #3
EL	1999		4 x 3.94" (100mm)	12mm x 1.5		H	A5/PN 6366-1	TSI PN 15393 #2
Integra	1986-03	14 x 6	4 x 3.94" (100mm)	12mm x 1.5	56.1	H	A5/PN 6366-1	TSI PN 15393 #2
Integra R	1999-03		5 x 4.5" (114.3mm)			H	A2/PN 6381-3	TSI PN 15392 #3
Legend	1986-90	15 x 6	4 x 4.5" (114.3mm)	12mm x 1.5	64.1	H	A5/PN 6366-4	TSI PN 15391 #4
Legend	1991-95	15 x 6.5	5 x 4.5" (114.3mm)	12mm x 1.5	70.3	H	A2/PN 6381-3	TSI PN 15392 #3
MDX	2003-07		5 x 4.5" (114.3mm)	12mm x 1.5	70.3	H	A2/PN 6381-3	TSI PN 15392 #3
MDX	2008-11		5 x 4.72" (120mm)		64.1	H	A 1/PN 6362-4	TSI PN 15394 #4
NSX	2004-09		5 x 4.5" (114.3mm)	12mm x 1.5	70.3	H	A2/PN 6381-3	TSI PN 15392 #3
ROX	2006-11		5 x 4.5" (114.3mm)		64.1	H	A2/PN 6381-3	TSI PN 15392 #3
RL	1997-04		5 x 4.5" (114.3mm)	12mm x 1.5	64.1	H	A2/PN 6381-3	TSI PN 15392 #3
RL	2005-11		5 x 4.72" (120mm)		64.1	H	A 1/PN 6362-4	TSI PN 15394 #4
RSX	2002-09		5 x 4.5" (114.3mm)	12mm x 1.5		H	A2/PN 6381-3	TSI PN 15392 #3
SLX	1996-98		6 x 5.5" (139.7mm)	12mm x 1.5	108	STD	A4/PN 6382-5	TSI PN 6285
TL	1996-98		4 x 4.5" (114.3mm)	12mm x 1.5	64.1	H	A5/PN 6366-4	TSI PN 15391 #4
TL	2010-11		5 x 4.72" (120mm)	12mm x 1.5	64.1	H	A 1/PN 6362-4	TSI PN 15394 #4
TL w/3.2 L	1996-03		5 x 4.5" (114.3mm)	12mm x 1.5	64.1	H	A2/PN 6381-3	TSI PN 15392 #3
TL/TLS	2004-09		5 x 4.5" (114.3mm)	12mm x 1.5	64.1	H	A2/PN 6381-3	TSI PN 15392 #3
TSX	2004-11		5 x 4.5" (114.3mm)		64.1	H	A2/PN 6381-3	TSI PN 15392 #3
Vigor	1992-94		5 x 4.5" (114.3mm)	12mm x 1.5	64.1	H	A2/PN 6381-3	TSI PN 15392 #3
Vigor	1995		4 x 4.5" (114.3mm)			H	A5/PN 6366-4	TSI PN 15391 #4

Disclaimer: All bolt circle data was acquired from tire service centers world wide. If conflicting information was available all of it was included in favor of eliminated it. TS/ is not responsible for accuracy of this input.

Tire Truer Adapters

Group H Adapter Series

- **PN 15276 HHD-001**
228.2/220.2 mm
- **PN 15069 HHD-002**
221.1/220.1 mm
- **PN 15068 HHD-011**
281.2/220.2 mm
- **PN 15447 HLD-003**
138.68/123.97/87 mm
- **PN 15448 HLD-004 (1-1/4" ID Bore)**
133.35/115.82/158.75 mm
- **PN 15199 HLD-005**
170.2/125.1 mm
- **PN 15575 HLD-012**
170.1/125.1 mm
- **PN 15499 HBP-001 Backing Plate**
9-5/8" Outside Diameter x 2" Inside Diameter
- **PN 15574 HBP-125**
9-5/8" Outside Diameter x 1-1/4" Inside Diameter



6343 BAN-LMM-AIG
Bandolero Legends
Formula 1



6386 Go Kart

Specifications

Each model ordered comes complete with a Mandrel Shaft Assembly consisting of: One Mandrel Shaft, two Mandrel Shaft Bearings and two Mandrel Shaft Locking Nuts.

Standard Electric

Required Power: 120 V, 60 Hz, 20 Amp Circuit

Cutter Blade Motor: 1/3 HP, 120 V, 60 Hz, 1 Phase

Tire Rotation Motor: 1/3 HP, 120 V, 60 Hz, 1 Phase

LED Lamp: 120 V, TSI PN 15297 Replacement

Option

Crossfeed Motor: 1/8 HP, 90 V, 60 Hz, 1 Phase

Unit Size

Each of the 711, 1100 & 1200-R units measure 46" long x 45" wide x 47" high

Truer Tire Size Capacity - standard units*

Model 711: 18" 0.0. minimum to 42" 0.0. maximum x 15" wide

Model 1200-R: 18" 0.0. minimum to 42" 0.0. maximum x 15" wide

* *Special order machines can handle smaller or larger diameter tires*

Stripper Ring Lathe Capacity

Model 1100: 10" 0.0. minimum to 21" 0.0. maximum x 17" wide



Specification

Each of the 711, 1100 and 1200R units measure 46" long x 45" wide x 47" high.

Working area for each unit requires enough space to load and unload each tire with access applicable for an operator to use the controls.

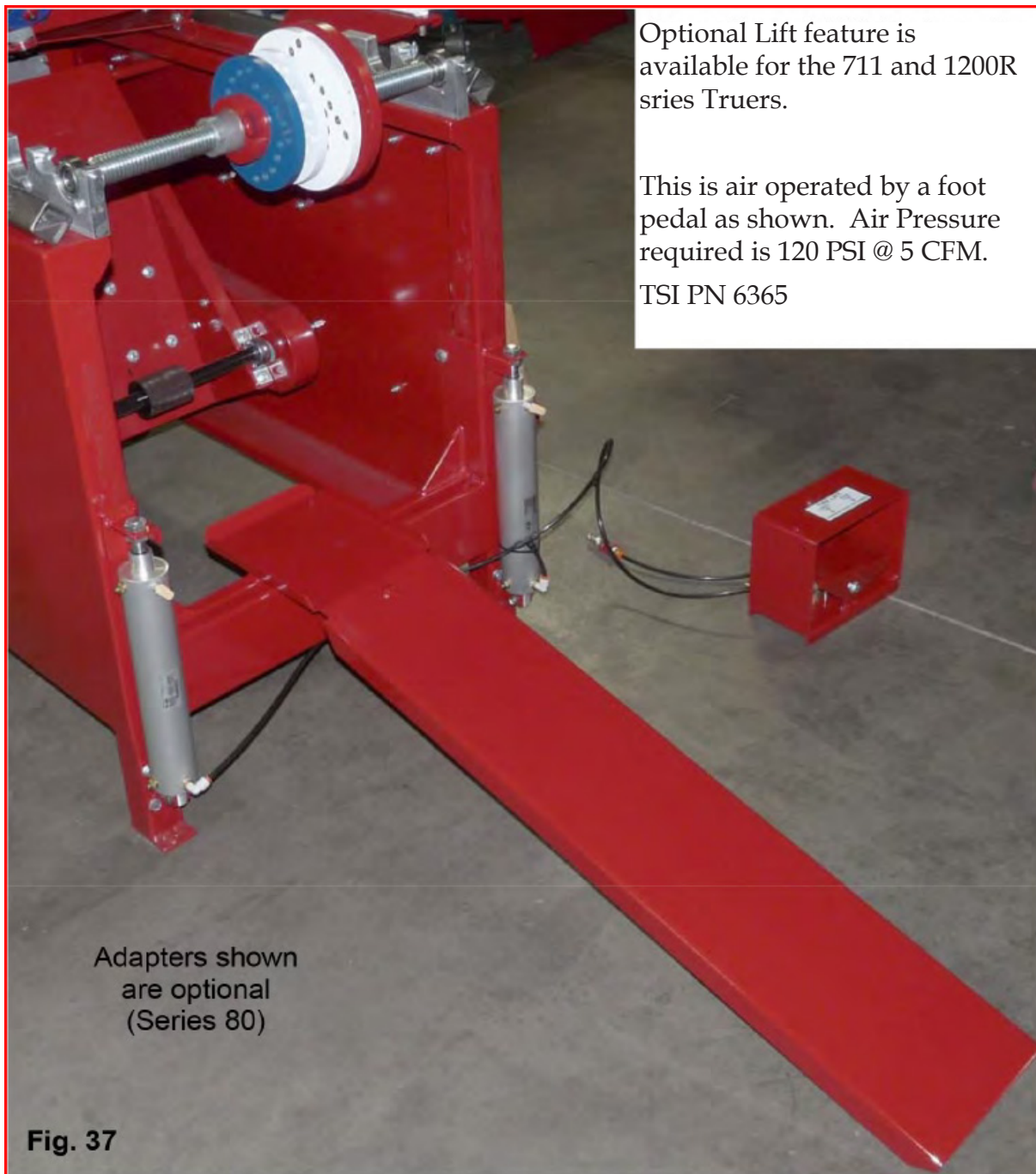

Optional Lift feature is available for the 711 and 1200R series Truers.

This is air operated by a foot pedal as shown. Air Pressure required is 120 PSI @ 5 CFM.

TSI PN 6365

Adapters shown are optional (Series 80)

Fig. 37

Notes

Repair Parts List

Item	Description
15067-60 Lower	Motor, Lower Electric 1/3 HP 60 Hz
15067-60 Upper	Motor, Upper Electric 1/3 HP 60Hz (rewired for reverse direction)
15226	Stone w/ 2 paper washers
15229	Stone Bolt (15229) & Nut (15021)
Adapters:	
6362	Wheel Adapter, A1 5 Lug metric
6381	Wheel Adapter, A2 5 Lug Inch
6364	Wheel Adapter, A3 3 Lug Metric
6382	Wheel Adapter, A4 3 Lug Inch
6366	Wheel Adapter, A5 Multi
6367	Wheel Adapter, A6 8-10 Lug P/U AL

Warranty and Return Policy

Warranty & Workmanship you can depend on.

With over 30 years of manufacturing experience we maintain the ability to provide competitive prices while employing and manufacturing the majority of our products in the USA. Pride in our workmanship and standing behind each and every product is not just our claim but our uncompromising responsibility.

Tire Service International equipment is warranted to be free from defects in materials and workmanship for a period of one year from the date of original purchase to the original owner. Repair labor is warranted for 90 days from the date of original purchase. Bushings, blades, bearings and normal wear and tear are not covered under warranty. Careless handling, negligence, misuse, abuse, mutilation, improper operation, making unauthorized repairs, additions, and or alterations automatically cancel this warranty and relieves TSI of any obligation. Cheetah tanks claimed to be defective while under warranty will be evaluated at our manufacturing plant and either repaired if possible or exchanged and returned or credit issued to the customer account at our discretion. Damage resulting from dropping the tanks will not receive warranty consideration. Warranty parts need to be returned prepaid to the plant for credit. Any replacement parts shipped from the plant will be shipped at the customer's expense. Machines requiring warranty work must be brought to the manufacturing plant in 201 Chelsea Rd, Monticello, MN or to a repair facility authorized by TSI. **!!WARNING!!** Goods returned without an RGA will be refused. A Returned Goods Authorization form must be obtained before returning any material or goods. All non-warranty returns will be subject to a 15% restocking fee plus any additional charges for reconditioning/repacking.

Visit www.buyTSI.com for any additional information. Also be sure to follow us on all the Socials, and subscribe to our YouTube channel for all our product videos.

Copyright © 2021 Tire Service International, LLC

No part of this manual may be reproduced
without specific approval from Tire Service
International, LLC.